

# 2

## Spannschlösser, Terminals und Drahtseile

Turnbuckles, terminals and wire ropes

Tendeurs, ridoirs, embouts à sertir et câbles

### 8245

#### Wantenspanner Gabel-Gabel / A4-AISI 316

Turnbuckle fork-fork / Ridoir à chapes



Bestell-Nr. Order no.	GW	ø	L1	L2	iB	iL	Antrieb Drive	**BL kg	Box	*€/Stück *€/piece
8245404	M4	4	170	110	5,5	8,5	SW7	480	10	
8245405	M5	5	190	130	6,5	10,0	SW7	790	10	
8245406	M6	6	220	150	7,5	10,0	SW8	1100	10	
8245408	M8	8	240	165	11,0	11,0	SW10	1750	10	
8245410	M10	9	280	190	12,0	14,0	SW13	3100	5	
8245412	M12	12	360	245	14,0	20,0	SW17	4570	5	
8245414	M14	12	390	270	15,0	22,0	SW19	5900	1	
8245416	M16	16	450	310	17,0	26,0	SW22	8000	1	
8245420	M20	19	510	360	20,0	30,0	SW27	12700	1	

Einzelteile Art.: 8418, 8386, 8432

Seperate parts art.: 8418, 8386, 8432

Pièces individuelles art.: 8418, 8386, 8432

### 815037

#### Wantenspanner Auge-Auge / A4-AISI 316

Turnbuckle eye-eye / Ridoir œil-œil

**NEW**

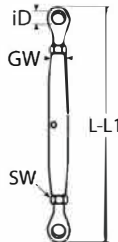

Bestell-Nr. Order no.	GW	iD	L	L1	Antrieb Drive	**BL kg	Box	*€/Stück *€/piece
815037404	M4	5,5	170	100	SW7	340	10	
815037405	M5	5,5	190	120	SW7	560	10	
815037406	M6	6,5	210	135	SW8	770	10	
815037408	M8	8,5	240	160	SW10	1390	10	
815037410	M10	10,5	280	190	SW13	2180	5	
815037412	M12	13,0	340	225	SW17	3200	5	
815037414	M14	13,0	380	250	SW19	4360	1	
815037416	M16	14,5	420	275	SW22	5700	1	
815037420	M20	19,5	480	330	SW27	8900	1	

Einzelteile Art.: 8418, 814863, 814864

Seperate parts art.: 8418, 814863, 814864

Pièces individuelles art.: 8418, 814863, 814864

# Spannschlösser, Terminals und Drahtseile

## Turnbuckles, terminals and wire ropes

## Tendeurs, ridoirs, embouts à sertir et câbles

# 2

### Wantenspanner Gabel-Terminal / A4-AISI 316

Turnbuckle fork-terminal / Ridoir chape à sertir

## 8275

Bestell-Nr. Order no.	GW	DS-Ø WR-Ø	ø	L1	L2	iL	iB	D1	Antrieb Drive	Box	*€/Stück *€/piece
8275405/25	M5	2,5	5	215	155	10	6,0	5,5	SW7	10	
8275406/3	M6	3,0	6	245	175	10	7,5	6,4	SW8	10	
8275406/4	M6	4,0	6	255	185	10	7,5	7,5	SW8	10	
8275408/4	M8	4,0	8	275	200	11	11,0	7,5	SW10	10	
8275408/5	M8	5,0	8	280	205	11	11,0	9,0	SW10	10	
8275410/5	M10	5,0	9	320	230	14	12,0	9,0	SW13	5	
8275410/6	M10	6,0	9	335	245	14	12,0	12,6	SW13	5	
8275412/6	M12	6,0	12	400	285	20	14,0	12,6	SW17	5	
8275412/8	M12	8,0	12	420	305	20	14,0	16,0	SW17	5	
8275414/7	M14	7,0	15	435	315	22	15,0	14,2	SW19	1	
8275416/8	M16	8,0	16	500	360	26	17,0	16,0	SW22	1	
8275416/10	M16	10,0	16	510	370	26	17,0	17,8	SW22	1	
8275420/10	M20	10,0	20	560	410	30	20,0	17,8	SW27	1	
8275420/12	M20	12,0	20	560	410	30	20,0	20,0	SW27	1	

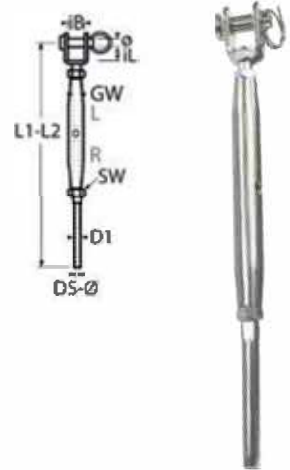

Einzelteile Art.: 8418, 8307, 8432

Seperate parts art.: 8418, 8307, 8432

Pièces individuelles art.: 8418, 8307, 8432

### Wantenspanner Toggle-Terminal / A4-AISI 316

Turnbuckle toggle-terminal / Ridoir chape articulée à sertir

## 8276

Bestell-Nr. Order no.	GW	DS-Ø WR-Ø	ø	L1	L2	iL	iB	D1	Antrieb Drive	Box	*€/Stück *€/piece
8276406/3	M6	3	6	250	180	15	7	6,4	SW8	5	
8276406/4	M6	4	6	260	190	15	7	7,5	SW8	5	
8276408/4	M8	4	8	285	210	20	10	7,5	SW10	5	
8276408/5	M8	5	8	290	215	20	10	9,0	SW10	5	
8276410/5	M10	5	9	340	250	25	12	9,0	SW13	5	
8276410/6	M10	6	9	355	265	25	12	12,6	SW13	5	
8276412/6	M12	6	12	410	300	30	13	12,6	SW17	5	
8276412/8	M12	8	12	430	320	30	13	16,0	SW17	5	
8276416/8	M16	8	16	530	390	40	17	16,0	SW22	1	
8276416/10	M16	10	16	540	400	40	17	17,8	SW22	1	
8276420/10	M20	10	19	590	450	45	20	17,8	SW27	1	



Einzelteile Art.: 8418, 8307, 8503

Seperate parts art.: 8418, 8307, 8503

Pièces individuelles art.: 8418, 8307, 8503

# 2

## Spannschlösser, Terminals und Drahtseile

Turnbuckles, terminals and wire ropes

Tendeurs, ridoirs, embouts à sertir et câbles

### 814065

Wantenspanner Gabel-Gabel, gedrehte Ausführung / A4-AISI 316

Turnbuckle fork-fork, machined / Ridoir à chapes usinées



Bestell-Nr. Order no.	GW	ø	L1	L2	iL	iB	Antrieb Drive	**BL kg	Box	*€/Stück *€/piece
814065405	M5	5	195	135	10	6,5	SW7	460	10	
814065406	M6	6	230	160	10	7,5	SW8	910	10	
814065408	M8	8	255	180	12	11,0	SW10	1330	10	
814065410	M10	9	300	210	14	12,0	SW13	2180	5	
814065412	M12	12	380	270	21	14,0	SW17	2300	5	
814065414	M14	12	415	295	22	15,0	SW19	2190	1	
814065416	M16	16	480	340	26	17,0	SW22	5310	1	

### 814066

Wantenspanner Gabel-Terminal, gedrehte Ausführung / A4-AISI 316

Turnbuckle fork-terminal, machined / Ridoir chape usinée à sertir

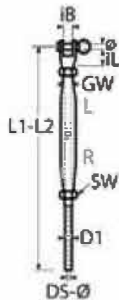

Bestell-Nr. Order no.	GW	DS-ø WR-ø	ø	L1	L2	iL	iB	D1	Antrieb Drive	Box	*€/Stück *€/piece
814066405/25	M5	2,5	5	215	155	10	6,5	5,5	SW7	10	
814066406/3	M6	3,0	6	250	180	10	7,5	6,4	SW8	10	
814066406/4	M6	4,0	6	260	190	10	7,5	7,5	SW8	10	
814066408/4	M8	4,0	8	285	210	12	11,0	7,5	SW10	10	
814066408/5	M8	5,0	8	290	215	12	11,0	9,0	SW10	10	
814066410/5	M10	5,0	9	330	240	14	12,0	9,0	SW13	5	
814066410/6	M10	6,0	9	345	255	14	12,0	12,6	SW13	5	
814066412/6	M12	6,0	12	410	300	21	14,0	12,6	SW17	5	
814066412/8	M12	8,0	12	430	320	21	14,0	16,0	SW17	5	
814066416/8	M16	8,0	16	510	370	26	17,0	16,0	SW22	1	
814066416/10	M16	10,0	16	520	380	26	17,0	17,8	SW22	1	

### 8386

Gabel mit Rechtsgewinde / A4-AISI 316

Fork with right thread / Chape avec filetage à droite

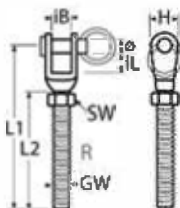

Bestell-Nr. Order no.	GW	ø	L1	L2	iL	iB	H	Antrieb Drive	Box	*€/Stück *€/piece
<b>NEW</b> 8386404	M4	4	52	36	8	6,5	12	SW7	10	
8386405	M5	5	65	42	10	6,5	13	SW8	10	
8386406	M6	6	72	48	10	7,5	15	SW10	10	
8386408	M8	8	81	56	11	11,0	19	SW13	10	
8386410	M10	9	96	63	14	12,0	21	SW17	5	
8386412	M12	12	122	80	20	14,0	27	SW19	5	
8386414	M14	12	127	89	22	15,0	27	SW22	1	
8386416	M16	16	158	103	26	17,0	38	SW24	1	

# Spannschlösser, Terminals und Drahtseile

## Turnbuckles, terminals and wire ropes

## Tendeurs, ridoirs, embouts à sertir et câbles

# 2

### Gabel mit Linksgewinde / A4-AISI 316

Fork with left thread / Chape avec filetage à gauche

## 8432

Bestell-Nr. Order no.	GW	ø	L1	L2	iL	iB	H	Antrieb Drive	Box	*€/Stück *€/piece
8432404	M4L	4	52	36	8	6,5	12	SW7	10	
8432405	M5L	5	65	42	10	6,5	13	SW8	10	
8432406	M6L	6	72	48	10	7,5	15	SW10	10	
8432408	M8L	8	81	56	11	11,0	19	SW13	10	
8432410	M10L	9	96	63	14	12,0	21	SW17	5	
8432412	M12L	12	122	80	20	14,0	27	SW19	5	
8432414	M14L	12	127	89	22	15,0	27	SW22	1	
8432416	M16L	16	158	103	26	17,0	38	SW24	1	

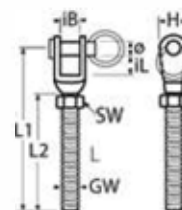

### Mini-Gabel mit Rechtsgewinde / A4-AISI 316

Mini-fork with right thread / Mini-chape avec filetage à droite

## 8452

Bestell-Nr. Order no.	GW	ø	L1	L2	iL	iB	Box	*€/Stück *€/piece
8452405	M5	5	40	20	10	8	10	
8452406	M6	6	47	25	10	8	10	
8452408	M8	8	52	25	12	10	5	
8452410	M10	10	72	45	14	12	5	

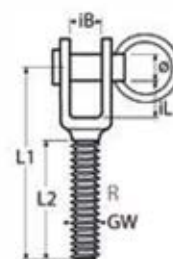

### Mini-Gabel mit Linksgewinde / A4-AISI 316

Mini-fork with left thread / Mini-chape avec filetage à gauche

## 8453

Bestell-Nr. Order no.	GW	ø	L1	L2	iL	iB	Box	*€/Stück *€/piece
8453405	M5L	5	40	20	10	8	10	
8453406	M6L	6	47	25	10	8	10	
8453408	M8L	8	52	25	12	10	5	
8453410	M10L	10	72	45	14	12	5	

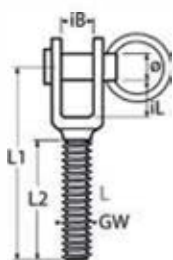

### Mini-Gabel mit Innengewinde, rechts / A4-AISI 316

Mini-fork with internal right thread / Mini-chape avec filetage interne à droite

## 8455

Bestell-Nr. Order no.	GW	ø	L1	iL1	iL	iB	D1	Box	*€/Stück *€/piece
8455405	M5	5	55	27	10	8	7,5	10	
8455406	M6	6	60	30	10	9	8,0	10	
8455408	M8	8	65	31	12	10	12,0	5	
8455410	M10	10	75	40	12	12	14,0	5	

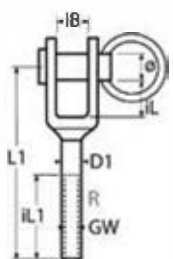

# 2

## Spannschlösser, Terminals und Drahtseile

Turnbuckles, terminals and wire ropes

Tendeurs, ridoirs, embouts à sertir et câbles

### 8456

Mini-Gabel mit Innengewinde, links / A4-AISI 316

Mini-fork with internal left thread / Mini-chape avec filetage interne à gauche

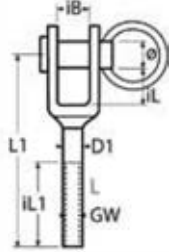

Bestell-Nr. Order no.	GW	ø	L1	iL1	iL	iB	D1	Box	*€/Stück *€/piece
8456405	M5L	5	55	27	10	8	7,5	10	
8456406	M6L	6	60	30	10	9	8,0	10	
8456408	M8L	8	65	31	12	10	12,0	5	
8456410	M10L	10	75	40	12	12	14,0	5	

### 8418

Spannschlossmutter ähnlich DIN 1478 / A4-AISI 316

Turnbuckle body similar to DIN 1478 / Corps de ridoir similaire DIN 1478

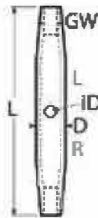

NEW

Bestell-Nr. Order no.	GW	L	D	iD	Box	*€/Stück *€/piece
8418404	M4	70	7,0	2,5	10	
8418405	M5	80	8,0	2,5	10	
8418406	M6	95	10,0	3,2	10	
8418408	M8	105	13,0	4,2	10	
8418410	M10	125	17,0	5,0	5	
8418412	M12	150	21,0	6,0	5	
8418414	M14	165	21,0	7,0	1	
8418416	M16	190	26,5	8,0	1	
8418420	M20	210	33,5	9,0	1	

### 8457

Mini Spannschlossmutter / A4-AISI 316

Mini turnbuckle body / Mini corps de ridoir

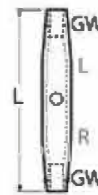

Bestell-Nr. Order no.	GW	L	D	iD	Box	*€/Stück *€/piece
8457405	M5	55	8	2,5	10	
8457406	M6	65	10	3,2	10	
8457408	M8	70	13	4,2	5	
8457410	M10	85	17	5,0	5	

### 8468

Kontermutter für Wantenspanner / A4-AISI 316

Counter nut for turnbuckle / Ecrou pour ridoir

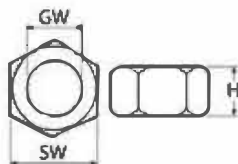

Bestell-Nr. R Order no. R	Bestell-Nr. L Order no. L	GW	H	Antrieb Drive	Box	*€/Stück *€/piece
84684R04	84684L04	M4/M4L	3,2	SW7	10	
84684R05	84684L05	M5/M5L	3,2	SW7	10	
84684R06	84684L06	M6/M6L	4,0	SW8	10	
84684R08	84684L08	M8/M8L	5,0	SW10	10	
84684R10	84684L10	M10/M10L	6,5	SW13	10	
84684R12	84684L12	M12/M12L	8,0	SW17	10	
84684R14	84684L14	M14/M14L	10,0	SW19	5	
84684R16	84684L16	M16/M16L	11,0	SW22	5	
84684R20	84684L20	M20/M20L	15,0	SW27	5	

# Spannschlösser, Terminals und Drahtseile

## Turnbuckles, terminals and wire ropes

### Tendeurs, ridoirs, embouts à sertir et câbles

# 2

### Spannschloss / A4-AISI 316

#### Turnbuckle / Tendeur

## 8246

Bestell-Nr. Order no.	GW	ø	L	L1	iD	C	**BL kg Typ A	Box	*€/Stück *€/piece
82464*A*B*C03	M3	2,7	130	90	5	5	50	10	
82464*A*B*C04	M4	3,5	135	95	6	6	120	10	
82464*A*B*C05	M5	4,3	165	110	8	7,5	160	10	
82464*A*B*C06	M6	5,3	210	145	10	9	320	10	
82464*A*B*C08	M8	7,0	280	190	14	12	560	10	
82464*A*B*C10	M10	8,9	345	240	16	13	880	5	
82464*A*B*C12	M12	10,9	455	300	18	14	1200	5	
82464*A*B*C16	M16	14,5	580	390	26	18	2400	1	
82464*A*B*C20	M20	18,3	680	460	30	20	3600	1	



\*A = Auge-Auge. Einzelteile Art.: 8417, 8433, 8434

\*B = Haken-Haken. Einzelteile Art.: 8417, 8435, 8436

\*C = Auge (Rechts)-Haken (Links). Einzelteile Art.: 8417, 8433, 8436

\*A = Eye-Eye. Seperate parts art.: 8417, 8433, 8434

\*B = Hook-Hook. Seperate parts art.: 8417, 8435, 8436

\*C = Eye (Right)-Hook (Left). Seperate parts art.: 8417, 8433, 8436

\*A = Oeil-Oeil. Pièces individuelles art.: 8417, 8433, 8434

\*B = Crochet-Crochet. Pièces individuelles art.: 8417, 8435, 8436

\*C = Oeil (pas à droite)-Crochet (pas à gauche). Pièces individuelles art.: 8417, 8433, 8436

Bruchlastangaben BL Kg nur für Typ A! / Breaking loads BL Kg only for type A! / Charges de rupture BL Kg unigment pour le type A!

### Spannschloss Haken-Haken mit Sicherung / A4-AISI 316

#### Turnbuckle hook-hook with spring snap / Tendeur crochet-crochet avec barrettes de sécurité

## 814932

Bestell-Nr. Order no.	GW	L	L1	C	Antrieb Drive	Box	*€/Stück *€/piece
814932406	M6	235	175	10	SW10	5	
814932408	M8	300	210	11	SW13	5	
814932412	M12	505	340	16	SW19	5	

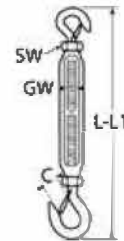

### Wantenspanner offen Gabel-Gabel / A4-AISI 316

#### Turnbuckle open body fork-fork / Tendeur à chapes

## 8339

Bestell-Nr. Order no.	GW	ø	L1	L2	iL	iB	Antrieb Drive	**BL kg	Box	*€/Stück *€/piece
8339405	M5	5	165	120	10	6,5	SW8	500	10	
8339406	M6	6	215	150	10	7,5	SW10	600	10	
8339408	M8	8	270	180	11	11,0	SW13	1100	10	
8339410	M10	9	330	220	19	12,0	SW17	1750	5	
8339412	M12	12	460	300	20	14,0	SW19	2300	5	
8339414	M14	12	500	325	22	15,0	SW22	3600	1	
8339416	M16	16	570	375	25	17,0	SW24	6800	1	
8339420	M20	19	680	450	31	20,0	SW30	8200	1	



Einzelteile Art.: 8417, 8386, 8432

Seperate parts art.: 8417, 8386, 8432

Pièces individuelles art.: 8417, 8386, 8432



# 2

## Spannschlösser, Terminals und Drahtseile

Turnbuckles, terminals and wire ropes

Tendeurs, ridoirs, embouts à sertir et câbles

### 8435

#### Hakenschraube mit Rechtsgewinde / A4-AISI 316

Hook screw with right thread / Crochet vis avec filetage à droite

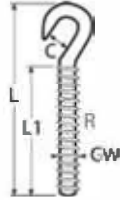

	Bestell-Nr. Order no.	GW	L	L1	C	Box	*€/Stück *€/piece
NEW	8435403	M3	45	27	5,0	10	
NEW	8435404	M4	46	27	6,0	10	
	8435405	M5	56	32	7,5	10	
	8435406	M6	70	42	9,0	10	
	8435408	M8	92	55	12,0	10	
	8435410	M10	113	70	13,0	5	
	8435412	M12	145	93	14,0	5	
	8435416	M16	189	115	18,0	1	
	8435420	M20	220	140	20,0	1	

### 8436

#### Hakenschraube mit Linksgewinde / A4-AISI 316

Hook screw with left thread / Crochet vis avec filetage à gauche

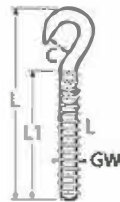

	Bestell-Nr. Order no.	GW	L	L1	C	Box	*€/Stück *€/piece
NEW	8436403	M3L	45	27	5,0	10	
NEW	8436404	M4L	46	27	6,0	10	
	8436405	M5L	56	32	7,5	10	
	8436406	M6L	70	42	9,0	10	
	8436408	M8L	92	55	12,0	10	
	8436410	M10L	113	70	13,0	5	
	8436412	M12L	145	93	14,0	5	
	8436416	M16L	189	115	18,0	1	
	8436420	M20L	220	140	20,0	1	

### 8433

#### Augschraube mit Rechtsgewinde / A4-AISI 316

Eye screw with right thread / Vis à œil avec filetage à droite

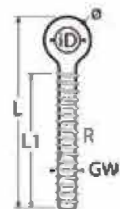

	Bestell-Nr. Order no.	GW	L	L1	iD	ø	Box	*€/Stück *€/piece
NEW	8433403	M3	45	27	5	2,7	10	
NEW	8433404	M4	46	27	6	3,5	10	
	8433405	M5	56	32	8	4,3	10	
	8433406	M6	70	42	10	5,3	10	
	8433408	M8	92	55	14	7,0	10	
	8433410	M10	113	70	16	8,9	5	
	8433412	M12	145	93	18	10,9	5	
	8433416	M16	189	115	26	14,5	1	
	8433420	M20	220	140	30	18,3	1	

# Spannschlösser, Terminals und Drahtseile

Turnbuckles, terminals and wire ropes  
Tendeurs, ridoirs, embouts à sertir et câbles

# 2

## Augschraube mit Linksgewinde / A4-AISI 316

Eye screw with left thread / Vis à œil avec filetage à gauche

### 8434

Bestell-Nr. Order no.	GW	L	L1	iD	ø	Box	*€/Stück *€/piece
8434403	M3L	45	27	5	2,7	10	
8434404	M4L	46	27	6	3,5	10	
8434405	M5L	56	32	8	4,3	10	
8434406	M6L	70	42	10	5,3	10	
8434408	M8L	92	55	14	7,0	10	
8434410	M10L	113	70	16	8,9	5	
8434412	M12L	145	93	18	10,9	5	
8434416	M16L	189	115	26	14,5	1	
8434420	M20L	220	140	30	18,3	1	

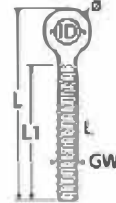

# 2

## Spannschlossmutter ähnlich DIN 1480 / A4-AISI 316

Open turnbuckle body similar to DIN 1480 / Corps de tendeur

### 8417

Bestell-Nr. Order no.	GW	L	Box	*€/Stück *€/piece
8417403	M3	60	10	
8417404	M4	58	10	
8417405	M5	70	10	
8417406	M6	90	10	
8417408	M8	120	10	
8417410	M10	150	5	
8417412	M12	200	5	
8417416	M16	250	1	
8417420	M20	300	1	

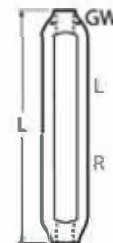



# 2

## Spannschlösser, Terminals und Drahtseile

Turnbuckles, terminals and wire ropes

Tendeurs, ridoirs, embouts à sertir et câbles

### 8307

**Terminal mit Rechtsgewinde / A4-AISI 316**

Terminal with right thread / Terminaison avec filetage à droite

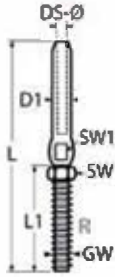

**NEW**

Bestell-Nr. Order no.	GW	DS-Ø WR-Ø	L	L1	D1	Antrieb Drive	Antrieb 2 Drive 2	Box	*€/Stück *€/piece
8307405/2	M5	2,0	86	40	5,5	SW8	SW4	10	
8307405/25	M5	2,5	86	40	5,5	SW8	SW4	10	
8307406/3	M6	3,0	100	48	6,4	SW10	SW5	10	
8307406/4	M6	4,0	110	48	7,5	SW10	SW6	10	
8307408/4	M8	4,0	117	57	7,5	SW13	SW6	10	
8307408/5	M8	5,0	124	57	9,0	SW13	SW7	10	
8307410/5	M10	5,0	130	63	9,0	SW17	SW7	5	
8307410/6	M10	6,0	145	63	12,6	SW17	SW10	5	
8307412/6	M12	6,0	162	80	12,6	SW19	SW10	5	
8307412/8	M12	8,0	180	80	16,0	SW19	SW14	5	
8307414/7	M14	7,0	180	90	14,2	SW22	SW12	1	
8307416/8	M16	8,0	200	100	16,0	SW24	SW14	1	
8307416/10	M16	10,0	210	100	17,8	SW24	SW15	1	
8307420/10	M20	10,0	230	119	17,8	SW30	SW15	1	
8307420/12	M20	12,0	245	120	20,0	SW30	SW17	1	
8307422/14	M22	14,0	308	140	25,0	SW32	SW22	1	
8307424/16	M24	16,0	363	170	28,0	SW36	SW24	1	

### 8467

**Terminal mit Linksgewinde / A4-AISI 316**

Terminal with left thread / Terminaison avec filetage à gauche

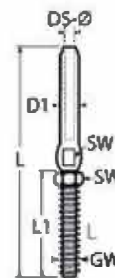

**NEW**

Bestell-Nr. Order no.	GW	DS-Ø WR-Ø	L	L1	D1	Antrieb Drive	Antrieb 2 Drive 2	Box	*€/Stück *€/piece
8467405/2	M5L	2,0	86	40	5,5	SW8	SW4	10	
8467405/25	M5L	2,5	86	40	5,5	SW8	SW4	10	
8467406/3	M6L	3,0	100	48	6,4	SW10	SW5	10	
8467406/4	M6L	4,0	110	48	7,5	SW10	SW6	10	
8467408/4	M8L	4,0	117	57	7,5	SW13	SW6	10	
8467408/5	M8L	5,0	124	57	9,0	SW13	SW7	10	
8467410/5	M10L	5,0	130	63	9,0	SW17	SW7	5	
8467410/6	M10L	6,0	145	63	12,6	SW17	SW10	5	
8467412/6	M12L	6,0	162	80	12,6	SW19	SW10	5	
8467412/8	M12L	8,0	180	80	16,0	SW19	SW14	5	
8467414/7	M14L	7,0	180	90	14,2	SW22	SW12	1	
8467416/8	M16L	8,0	200	100	16,0	SW24	SW14	1	
8467416/10	M16L	10,0	210	100	17,8	SW24	SW15	1	
8467420/10	M20L	10,0	230	119	17,8	SW30	SW15	1	
8467420/12	M20L	12,0	245	120	20,0	SW30	SW17	1	

# Spannschlösser, Terminals und Drahtseile

Turnbuckles, terminals and wire ropes  
Tendeurs, ridoirs, embouts à sertir et câbles

# 2

## Mini-Terminal mit Rechtsgewinde / A4-AISI 316

Mini-terminal with right thread / Mini-terminaison avec filetage à droite

### 8445

Bestell-Nr. Order no.	DS-Ø WR-Ø	GW	L	L1	iL	D1	Box	*€/Stück *€/piece
8445405/2	2	M5	50	27	18	5,5	10	
8445405/3	3	M5	50	27	18	6,4	10	
8445406/4	4	M6	60	30	26	7,5	10	
8445408/5	5	M8	70	31	32	9,0	5	
8445410/6	6	M10	85	40	38	12,6	5	

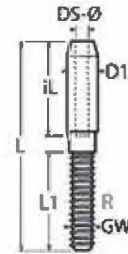

## Mini-Terminal mit Linksgewinde / A4-AISI 316

Mini-terminal with left thread / Mini-terminaison avec filetage à gauche

### 8446

Bestell-Nr. Order no.	DS-Ø WR-Ø	GW	L	L1	iL	D1	Box	*€/Stück *€/piece
8446405/2	2	M5L	50	18	18	5,5	10	
8446405/3	3	M5L	50	27	18	6,4	10	
8446406/4	4	M6L	60	30	26	7,5	10	
8446408/5	5	M8L	70	31	32	9,0	5	
8446410/6	6	M10L	85	40	38	12,6	5	

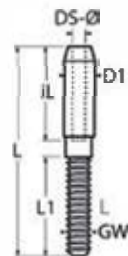

## Mini-Terminal mit Rechtsgewinde, lang / A4-AISI 316

Mini-terminal with right thread, long / Mini-terminaison avec filetage long à droite

### 814866

Bestell-Nr. Order no.	DS-Ø WR-Ø	GW	L	L1	iL	D1	Box	*€/Stück *€/piece
814866405/3	3	M5	73	50	18	6,4	10	
814866406/4	4	M6	89	60	26	7,5	10	
814866408/5	5	M8	98	60	32	9,0	5	
814866410/6	6	M10	124	80	38	12,6	5	

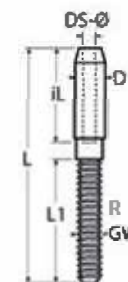

## Mini-Terminal mit Linksgewinde, lang / A4-AISI 316

Mini-terminal with left thread, long / Mini-terminaison avec filetage long à gauche

### 814867

Bestell-Nr. Order no.	DS-Ø WR-Ø	GW	L	L1	iL	D1	Box	*€/Stück *€/piece
814867405/3	3	M5L	73	50	18	6,4	10	
814867406/4	4	M6L	89	60	26	7,5	10	
814867408/5	5	M8L	98	60	32	9,0	5	
814867410/6	6	M10L	124	80	38	12,6	5	

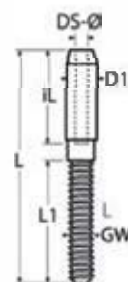

# 2

## Spannschlösser, Terminals und Drahtseile Turnbuckles, terminals and wire ropes Tendeurs, ridoirs, embouts à sertir et câbles

### 8449

**Mini-Terminal mit Innengewinde, rechts / A4-AISI 316**  
Mini-terminal with internal right thread / Mini-terminaison avec filetage interne à droite

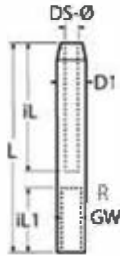

Bestell-Nr. Order no.	DS-Ø WR-Ø	GW	L	iL	iL1	D1	Box	*€/Stück *€/piece
8449405/3	3	M5	55	28	20	6,4	10	
8449406/4	4	M6	65	36	22	7,5	10	
8449406/5	5	M6	70	41	22	9,0	5	
8449408/6	6	M8	85	53	25	12,6	5	

### 8450

**Mini-Terminal mit Innengewinde, links / A4-AISI 316**  
Mini-terminal with internal left thread / Mini-terminaison avec filetage interne à gauche

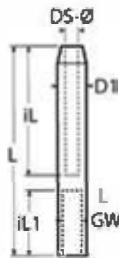

Bestell-Nr. Order no.	DS-Ø WR-Ø	GW	L	iL	iL1	D1	Box	*€/Stück *€/piece
8450405/3	3	M5L	55	28	20	6,4	10	
8450406/4	4	M6L	65	36	22	7,5	10	
8450406/5	5	M6L	70	41	22	9,0	5	
8450408/6	6	M8L	85	53	25	12,6	5	

### 8466

**Gewindestück, Rechts und Links / A4-AISI 316**  
Stud bolt, right and left thread / Terminaison avec filetage à droite et à gauche

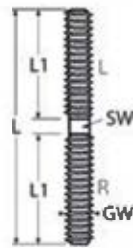

Bestell-Nr. Order no.	GW	L	L1	Antrieb Drive	Box	*€/Stück *€/piece
8466405	M5	65	30	SW3	10	
8466406	M6	65	30	SW4	10	
8466408	M8	65	30	SW6	5	
8466410	M10	85	40	SW7	5	
8466412	M12	105	50	SW8	5	

### 8459

**Mini-Senkopfterminal / A4-AISI 316**  
Mini-cone terminal / Mini-terminaison à tête plate à sertir

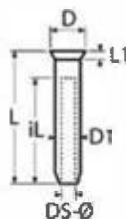

Bestell-Nr. Order no.	DS-Ø WR-Ø	L	L1	iL	D	D1	Box	*€/Stück *€/piece
845943	3	34	2	27	8,0	6,4	10	
845944	4	43	2	35	9,5	7,5	10	
845945	5	50	3	40	13,0	9,0	5	
845946	6	64	3	50	16,5	12,6	5	

# Spannschlösser, Terminals und Drahtseile

## Turnbuckles, terminals and wire ropes

### Tendeurs, ridoirs, embouts à sertir et câbles

# 2

### Mini-Linsenkopfterminal, dünnwandig / A4-AISI 316

Mini-dome head terminal, thin walled / Mini-terminaison à tête cylindrique bombée à sertir

## 8448

Bestell-Nr. Order no.	DS-Ø WR-Ø	L	L1	iL	D	D1	Box	*€/Stück *€/piece
844843	3	25	2,0	18	9	5,5	10	
844844	4	30	2,0	24	11	6,4	10	
844845	5	35	2,5	28	13	7,5	5	
844846	6	40	3,0	32	16	9,0	5	

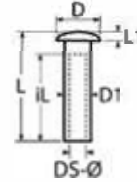

Terminal muß mit einer Press- oder Walzbackengröße kleiner verarbeitet werden. Siehe Maßangabe D1.

Terminals must be pressed or swaged with jaws one size smaller. See dimension D1.

Le terminal doit être traité avec une mâchoire de presse ou de rouleau de plus petite taille. Voir dimension D1.

### Linsenkopfhülse mit Innengewinde / A4-AISI 316

Dome case nut with internal thread / Tête bombée avec filetage interne

## 8464

Bestell-Nr. Order no.	GW	L	L1	iL	D	D1	Antrieb Drive	Box	*€/Stück *€/piece
8464405	M5	25	4	18	7,5	12	SW5	10	
8464406	M6	30	4	24	8,0	12	SW5	10	
8464408	M8	35	5	28	12,0	16	SW6	5	
8464410	M10	40	6	32	14,0	20	SW6	5	

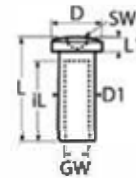

### Terminal mit Holzgewinde, rechts / A4-AISI 316

Terminal with right-hand wood thread / Terminaison avec filetage bois à droite

## 814087

Bestell-Nr. Order no.	DS-Ø WR-Ø	GW	L	L1	D1	Antrieb Drive	Box	*€/Stück *€/piece
814087403	3	6	97	48	6,4	SW5	10	
814087404	4	8	115	54	7,5	SW6	10	
814087405	5	10	128	61	9,0	SW7	5	
814087406	6	12	162	79	12,6	SW10	5	

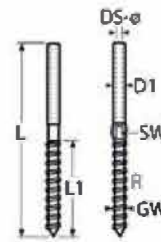

### Terminal mit Holzgewinde, links / A4-AISI 316

Terminal with left-hand wood thread / Terminaison avec filetage bois à gauche

## 814088

Bestell-Nr. Order no.	DS-Ø WR-Ø	GW	L	L1	D1	Antrieb Drive	Box	*€/Stück *€/piece
814088403	3	6	97	48	6,4	SW5	10	
814088404	4	8	115	54	7,5	SW6	10	
814088405	5	10	128	61	9,0	SW7	5	
814088406	6	12	162	79	12,6	SW10	5	

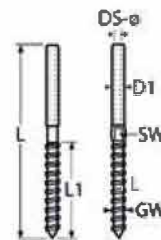

# 2

## Spannschlösser, Terminals und Drahtseile

Turnbuckles, terminals and wire ropes

Tendeurs, ridoirs, embouts à sertir et câbles

### 8484

**Anschweißende mit Rechtsgewinde / A4-AISI 316**

Rod end right threaded for welding / Tige à souder avec filetage à droite

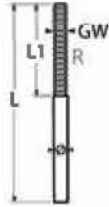

Bestell-Nr. Order no.	GW	ø	L	L1	Box	*€/Stück *€/piece
8484405	M5	4,4	85	40	10	
8484406	M6	5,2	100	45	10	
8484408	M8	7,0	112	52	10	
8484410	M10	8,8	127	62	5	
8484412	M12	10,7	140	75	5	
8484414	M14	12,5	150	82	1	
8484416	M16	14,2	170	95	1	
8484420	M20	18,1	185	105	1	

### 8511

**Anschweißende mit Linksgewinde / A4-AISI 316**

Rod end left threaded for welding / Tige à souder avec filetage à gauche



Bestell-Nr. Order no.	GW	ø	L	L1	Box	*€/Stück *€/piece
8511405	M5L	4,4	85	40	10	
8511406	M6L	5,2	100	45	10	
8511408	M8L	7,0	112	52	10	
8511410	M10L	8,8	127	62	5	
8511412	M12L	10,7	140	75	5	
8511414	M14L	12,5	150	82	1	
8511416	M16L	14,2	170	95	1	
8511420	M20L	18,1	185	105	1	

### 8281

**Augterminal / A4-AISI 316**

Eye terminal / Embout à œil à sertir

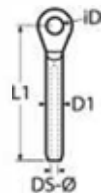

Bestell-Nr. Order no.	DS-ø WR-ø	L1	iD	D1	Box	*€/Stück *€/piece
82814025	2,5	49	5,4	5,5	10	
8281403	3,0	55	6,5	6,4	10	
8281404	4,0	56	8,5	7,5	10	
8281405	5,0	80	10,5	9,0	5	
8281406	6,0	94	12,5	12,6	5	
8281407	7,0	105	12,7	14,2	5	
8281408	8,0	124	14,5	16,0	1	
8281410	10,0	142	16,4	17,8	1	
8281412	12,0	160	19,3	20,0	1	

# Spannschlösser, Terminals und Drahtseile

## Turnbuckles, terminals and wire ropes

## Tendeurs, ridoirs, embouts à sertir et câbles

# 2

### Mini-Augterminal / A4-AISI 316

Mini-eye terminal / Mini-embout à œil à sertir

## 8469

Bestell-Nr. Order no.	DS-Ø WR-Ø	L1	iL	iD	S	D1	Box	*€/Stück *€/piece
846943	3	40	18	6,5	5	6,4	10	
846944	4	52	24	8,5	6	7,5	10	
846945	5	62	30	9,5	7	9,0	5	
846946	6	75	36	13,0	8	12,6	5	

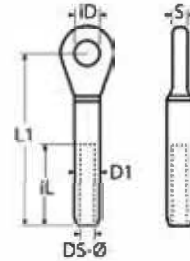

# 2

### Auge mit Rechtsgewinde / A4-AISI 316

Eye with right thread / Œil avec filetage à droite

## 814863

Bestell-Nr. Order no.	GW	L1	L2	iD	S	Antrieb Drive	Box	*€/Stück *€/piece
814863405	M5	60	42	5,5	3	SW8	10	
814863406	M6	66	48	6,5	4	SW10	10	
814863408	M8	78	56	8,5	5	SW13	5	
814863410	M10	91	63	10,5	6	SW17	5	
814863412	M12	112	80	13,0	8	SW19	5	

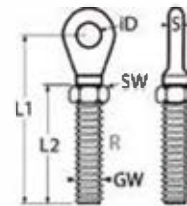

### Auge mit Linksgewinde / A4-AISI 316

Eye with left thread / Œil avec filetage à gauche

## 814864

Bestell-Nr. Order no.	GW	L1	L2	iD	S	Antrieb Drive	Box	*€/Stück *€/piece
814864405	M5L	60	42	5,5	3	SW8	10	
814864406	M6L	66	48	6,5	4	SW10	10	
814864408	M8L	78	56	8,5	5	SW13	5	
814864410	M10L	91	63	10,5	6	SW17	5	
814864412	M12L	112	80	13,0	8	SW19	5	

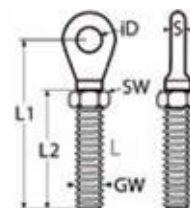



# 2

## Spannschlösser, Terminals und Drahtseile

Turnbuckles, terminals and wire ropes

Tendeurs, ridoirs, embouts à sertir et câbles

### 8454

#### Mini-Auge mit Rechtsgewinde / A4-AISI 316

Mini-eye with right thread / Mini-œil avec filetage à droite

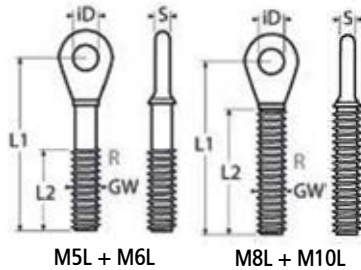

M5L + M6L

M8L + M10L

Bestell-Nr. Order no.	GW	L1	L2	iD	S	Box	*€/Stück *€/piece
8454405	M5	45	23	5,5	3	10	
8454406	M6	47	28	6,5	4	10	
8454408	M8	55	40	8,5	5	5	
8454410	M10	65	47	10,5	6	5	

M5 und M6 mit Teilgewinde. / M5 and M6 with partial thread / M5 et M6 avec filetage partie.

M8 und M10 mit Vollgewinde. / M8 and M10 with full thread / M6 et M10 avec filetage complet.

### 8458

#### Mini-Auge mit Linksgewinde / A4-AISI 316

Mini-eye with left thread / Mini-œil avec filetage à gauche

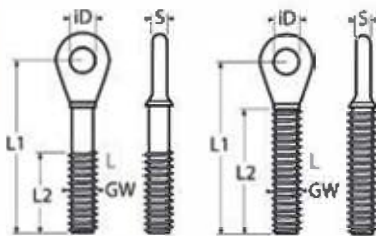

M5L + M6L

M8L + M10L

Bestell-Nr. Order no.	GW	L1	L2	iD	S	Box	*€/Stück *€/piece
8458405	M5L	45	23	5,5	3	10	
8458406	M6L	47	28	6,5	4	10	
8458408	M8L	55	40	8,5	5	5	
8458410	M10L	65	47	10,5	6	5	

M5L und M6L mit Teilgewinde. / M5L and M6L with partial thread. / M5L et M6L avec filetage partie.

M8L und M10L mit Vollgewinde. / M8L and M10L with full thread. / M6L et M10L avec filetage complet.

### 8282

#### T-Terminal / A4-AISI 316

T-terminal / Embout en T à sertir



Bestell-Nr. Order no.	DS-Ø WR-Ø	L	D1	Box	*€/Stück *€/piece
8282403	3	85	6,4	10	
8282404	4	100	7,5	10	
8282405	5	115	9,0	10	
8282406	6	140	12,6	5	
8282407	7	145	14,2	5	
8282408	8	185	16,0	1	
8282410	10	215	19,0	1	

In Kombination mit Artikel 8302.

In combination with article 8302.

En combinaison avec d'article 8302.

# Spannschlösser, Terminals und Drahtseile

## Turnbuckles, terminals and wire ropes

### Tendeurs, ridoirs, embouts à sertir et câbles

# 2

### Halteplatte für T-Terminal / A4-AISI 316

Back plate for T-terminal / Plaque d'ancrage pour embout en T

## 8302

Bestell-Nr. Order no.	DS-Ø WR-Ø	L	B	iL	iB	BD	Box	*€/Stück *€/piece
8302404	3+4	88	27	27	9,9	5,0	10	
8302405	5	88	27	27	9,9	5,0	10	
8302406	6	122	39	35	15,6	6,3	5	
8302407	7	122	39	35	15,9	6,4	5	
8302408	8	151	39	41	18,8	6,5	1	
8302410	10	151	39	41	18,8	6,5	1	

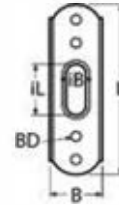

### Haketerminal / A4-AISI 316

Hook terminal / Embout croché à sertir

## 814865

Bestell-Nr. Order no.	DS-Ø WR-Ø	L	iB	D1	Box	*€/Stück *€/piece
814865403	3	73	12	6,4	10	
814865404	4	90	18	7,5	10	

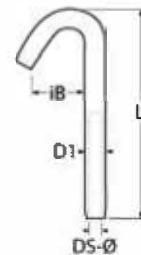

### Gabelterminal / A4-AISI 316

Fork terminal / Embout à chape à sertir

## 8280

Bestell-Nr. Order no.	DS-Ø WR-Ø	Ø	L1	iL	iB	D1	Box	*€/Stück *€/piece
8280402	2,0	4,0	55	8,0	5,5	5,5	10	
82804025	2,5	5,0	55	10,0	6,5	5,5	10	
8280403	3,0	6,4	65	10,0	6,5	6,4	10	
8280404-6	4,0	6,0	77	11,0	10,0	7,5	10	
8280404	4,0	8,0	77	11,0	11,0	7,5	10	
8280405	5,0	9,0	88	14,0	12,0	9,0	5	
8280406	6,0	12,0	106	20,0	14,0	12,6	5	
8280407	7,0	12,0	116	22,0	15,0	14,2	5	
8280408	8,0	16,0	145	26,0	17,0	16,0	5	
8280410	10,0	18,0	150	30,0	20,0	19,0	1	
8280412	12,0	19,0	195	35,0	23,0	20,0	1	
8280414	14,0	22,0	232	46,5	30,0	25,0	1	
8280416	16,0	25,0	264	49,0	30,0	28,0	1	

NEW

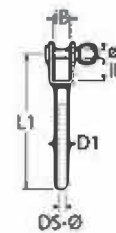

# 2

## Spannschlösser, Terminals und Drahtseile

Turnbuckles, terminals and wire ropes

Tendeurs, ridoirs, embouts à sertir et câbles

### 8447

**Mini-Gabelterminal / A4-AISI 316**

Mini-fork terminal / Mini-embout à chape à sertir



Bestell-Nr. Order no.	DS-Ø WR-Ø	ø	L1	iL	iB	D1	Box	*€/Stück *€/piece
844743	3	5	55	10	8	6,4	10	
844744	4	6	65	10	8	7,5	10	
844745	5	8	70	12	10	9,0	5	
844746	6	10	85	14	12	12,6	5	

### 814067

**Gabelterminal, gedrehte Ausführung / A4-AISI 316**

Fork terminal, machined / Embout à chape usinée à sertir

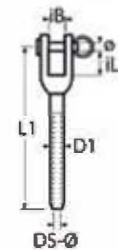

Bestell-Nr. Order no.	DS-Ø WR-Ø	ø	L	iL	iB	D1	Box	*€/Stück *€/piece
814067403	3	6	73	10	7,5	6,4	10	
814067404	4	8	86	11	11	7,5	10	
814067405	5	9	100	14	12	9,0	5	
814067406	6	12	128	20	14	12,6	5	
814067407	7	12	135	22	15	14,2	5	
814067408	8	16	155	26	17	16,0	5	

### 8483

**Toggle-Terminal / A4-AISI 316**

Toggle terminal / Embout à chape articulée à sertir

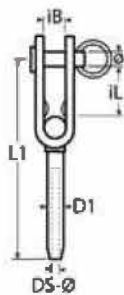

Bestell-Nr. Order no.	DS-Ø WR-Ø	ø	L1	iL	iB	D1	Box	*€/Stück *€/piece
8483403	3	6	75	15	7	6,4	5	
8483404	4	8	89	20	10	7,5	5	
8483405	5	9	104	25	12	9,0	5	
8483406	6	12	127	30	13	12,6	5	
8483408	8	16	163	40	17	16,0	1	
8483410	10	19	184	45	20	20,0	1	

### 815016

**Toggle Terminal zur Wandbefestigung, MT-Serie / A4-AISI 316**

Wall mounting toggle terminal, MT series / Embout articulé mural à sertir, Série MT



## NEW

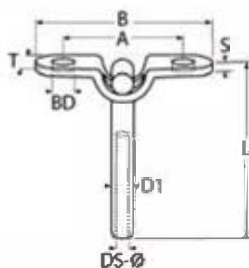

Bestell-Nr. Order no.	DS-Ø WR-Ø	L	B	T	D1	A	S	BD	Box	*€/Stück *€/piece
815016403	3	53	50	20	6,4	35	3	6,3	5	
815016404	4	63	50	20	7,5	35	3	6,3	5	
815016405	5	68	60	25	9,0	40	3	8,4	2	
815016406	6	79	75	30	12,6	50	4	10,5	2	

# Spannschlösser, Terminals und Drahtseile

## Turnbuckles, terminals and wire ropes

## Tendeurs, ridoirs, embouts à sertir et câbles

# 2

### Toggle mit Rechtsgewinde / A4-AISI 316

Toggle with right thread / Chape articulée avec filetage à droite

## 8486

Bestell-Nr. Order no.	GW	ø	L1	L2	iL	iB	Antrieb Drive	Box	*€/Stück *€/piece
8486405	M5	5	62	42	13	6	SW8	10	
8486406	M6	6	77	48	15	7	SW10	10	
8486408	M8	8	94	56	20	10	SW13	5	
8486410	M10	9	115	67	25	12	SW17	5	
8486412	M12	12	136	81	30	13	SW19	5	
8486416	M16	16	163	103	40	17	SW24	1	
8486420	M20	19	198	115	45	20	SW30	1	

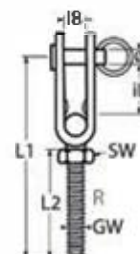

### Toggle mit Linksgewinde / A4-AISI 316

Toggle with left thread / Chape articulée avec filetage à gauche

## 8503

Bestell-Nr. Order no.	GW	ø	L1	L2	iL	iB	Antrieb Drive	Box	*€/Stück *€/piece
8503405	M5L	5	62	42	13	6	SW8	10	
8503406	M6L	6	77	48	15	7	SW10	10	
8503408	M8L	8	94	56	20	10	SW13	5	
8503410	M10L	9	115	67	25	12	SW17	5	
8503412	M12L	12	136	81	30	13	SW19	5	
8503414	M14L	14	140	89	35	15	SW22	1	
8503416	M16L	16	163	103	40	17	SW24	1	
8503420	M20L	19	198	115	45	20	SW30	1	

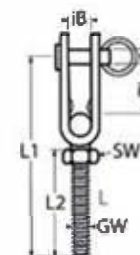

### Toggle mit Gewinde zur Wandbefestigung, MT-Serie / A4-AISI 316

Wall mounting toggle with thread, MT series / Embout fileté articulé mural à sertir, Série MT

## 815017

## NEW

Bestell-Nr. Order no.	GW	L	L1	B	T	A	S	BD	Box	*€/Stück *€/piece
815017405	M5	55	40	50	20	35	3	6,3	5	
815017405L	M5L	55	40	50	20	35	3	6,3	5	
815017406	M6	57	40	50	20	35	3	6,3	5	
815017406L	M6L	57	40	50	20	35	3	6,3	5	
815017408	M8	68	50	60	25	40	3	8,4	2	
815017408L	M8L	68	50	60	25	40	3	8,4	2	
815017410	M10	74	50	75	30	50	4	10,5	2	
815017410L	M10L	74	50	75	30	50	4	10,5	2	

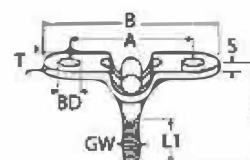

# 2

## Spannschlösser, Terminals und Drahtseile

Turnbuckles, terminals and wire ropes

Tendeurs, ridoirs, embouts à sertir et câbles

### 8278

**Toggle Gabel-Auge / A4-AISI 316**

Toggle fork-eye / Articulation de chape

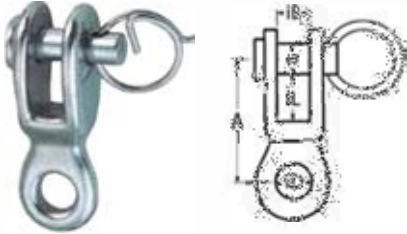

Bestell-Nr. Order no.	ø	iD	iL	iB	A	Box	*€/Stück *€/piece
8278405	5,2	5,5	7	6	22	5	
8278406	6,3	6,6	9	7	27	5	
8278408	8,3	8,5	10	10	31	5	
8278410	9,3	10,0	12	12	36	1	
8278412	12,4	13,0	17	13	50	1	
8278414	15,0	14,3	20	15	60	1	
8278416	17,0	17,0	29	14	80	1	

### 8403

**DIY Montage-Augterminal / A4-AISI 316**

DIY quick attach eye terminal / DIY embout à ceill à sertissage manuel

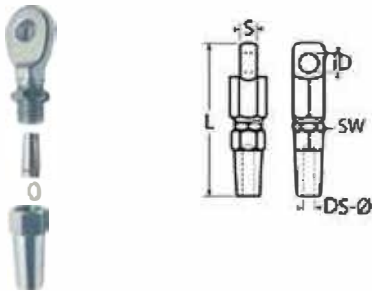

Bestell-Nr. Order no.	DS-ø WR-ø	L	iD	S	Antrieb Drive	Box	*€/Stück *€/piece
8403404	4	67	8	6,5	SW14	1	
8403405	5	80	10	8,0	SW16	1	
8403406	6	95	12	9,0	SW19	1	
8403408	8	119	14	10,0	SW24	1	

Für Seile: 1x19 / 7x7 / 7x19 · BL= ca. 85% der Drahtseilbruchlast

For wire rope: 1x19 / 7x7 / 7x19 · BL= ca. 85% of wire rope breaking load

Pour câbles 1x19 / 7x7 / 7x19 · BL = ca. 85% de la charge de rupture du câble.

Technische Information Seite 465  
 Technical information page 465  
 Informations techniques page 465

### 8404

**DIY Montage-Gabelterminal / A4-AISI 316**

DIY quick attach eye terminal / DIY embout à ceill à sertissage manuel

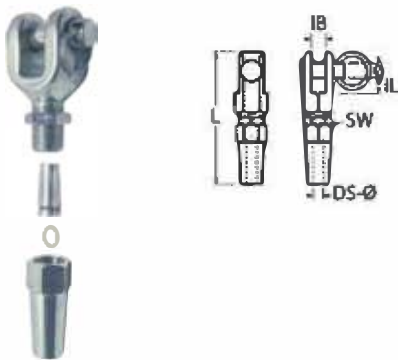

Bestell-Nr. Order no.	DS-ø WR-ø	ø	L	iL	iB	Antrieb Drive	Box	*€/Stück *€/piece
8404404	4	8	72	8	8	SW14	1	
8404405	5	10	82	10	10	SW16	1	
8404406	6	12	94	12	12	SW19	1	
8404408	8	14	116	14	14	SW24	1	

Für Seile: 1x19 / 7x7 / 7x19 · BL= ca. 85% der Drahtseilbruchlast

For wire rope: 1x19 / 7x7 / 7x19 · BL= ca. 85% of wire rope breaking load

Pour câbles 1x19 / 7x7 / 7x19 · BL = ca. 85% de la charge de rupture du câble.

Technische Information Seite 465  
 Technical information page 465  
 Informations techniques page 465

# Spannschlösser, Terminals und Drahtseile

## Turnbuckles, terminals and wire ropes

## Tendeurs, ridoirs, embouts à sertir et câbles

# 2

### DIY Montage-Gewindeterminale / A4-AISI 316

DIY quick attach eye terminal / DIY embout à œil à sertissage manuel

## 8406

Bestell-Nr. Order no.	DS-Ø WR-Ø	GW	L	L1	Antrieb Drive	Box	*€/Stück *€/piece
8406404	4	M8	100	57	SW14	1	
8406405	5	M10	117	63	SW16	1	
8406406	6	M12	145	80	SW19	1	
8406408	8	M16	182	100	SW24	1	

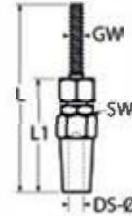

Für Seile: 1x19 / 7x7 / 7x19 · BL= ca. 85% der Drahtseilbruchlast

For wire rope: 1x19 / 7x7 / 7x19 · BL= ca. 85% of wire rope breaking load

Pour câbles 1x19 / 7x7 / 7x19 · BL = ca. 85% de la charge de rupture du câble.

Technische Information Seite 465  
 Technical information page 465  
 Informations techniques page 465

### DIY Schraubterminale mit Innengewinde / A4-AISI 316

DIY terminal with internal thread / DIY embout avec filetage interne à sertissage man.

## 8451

Bestell-Nr. Order no.	DS-Ø WR-Ø	GW	L	iL	iL1	D1	Box	*€/Stück *€/piece
8451434RE	3+4	M6	80	45	35	12	5	
8451434LI	3+4	M6L	80	45	35	12	5	
8451405RE	5	M6	80	45	35	12	5	
8451405LI	5	M6L	80	45	35	12	5	

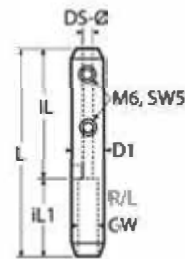

### DIY Schraubterminale mit Gewindestift / A4-AISI 316

DIY terminal with set screw / DIY embout avec filetage externe à sertissage man.

## 814868

Bestell-Nr. Order no.	DS-Ø WR-Ø	GW	L	L1	L2	D1	Box	*€/Stück *€/piece
814868405/3	3	M5	87	53	34	11	5	
814868406/4	4	M6	95	58	37	13	5	
814868406/5	5	M6	102	65	37	14	2	
814868408/6	6	M8	118	73	45	16	2	

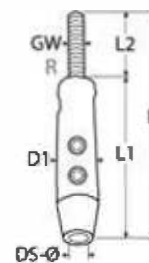

Der Gewindestift ist herausdrehbar.

The grub screw is removable.

La vis sans tête est amovible.



# 2

## Spannschlösser, Terminals und Drahtseile

Turnbuckles, terminals and wire ropes

Tendeurs, ridoirs, embouts à sertir et câbles

### 8346

Wantenversteller / A4-AISI 316

Stay adjuster / Latte ridoir

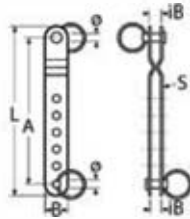

Bestell-Nr. Order no.	ø	L	B	iB	A	S	Box	*€/Stück *€/piece
83464104	5	104	15	10	87	1,5	5	

### 8350

Wantenversteller / A2-AISI 304

Stay adjuster / Latte ridoir

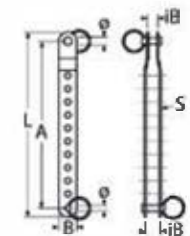

Bestell-Nr. Order no.	ø	L	B	iB	A	S	Box	*€/Stück *€/piece
83502100	5	100	15	9	84	1,5	5	
83502155	5	155	15	9	145	1,5	5	
83502200	5	200	15	9	184	1,5	5	

### 8283

Pelikanhaken mit Innengewinde / A4-AISI 316

Pelican hook with internal thread / Crochet pélican avec filetage interne



Bestell-Nr. Order no.	GW	L	iD	**BL kg	Box	*€/Stück *€/piece
8283406	M6	75	18,5	570	1	
8283408	M8	100	27,0	1030	1	
8283410-125	M10	125	35,0	1590	1	
8283410	M10	144	35,0	1590	1	
8283412	M12	150	39,0	1750	1	

### 814077

Pelikanhaken mit Auge / A4-AISI 316

Pelican hook with eye / Crochet pélican à œil

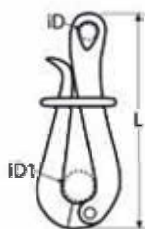

Bestell-Nr. Order no.	L	iD	iD1	Box	*€/Stück *€/piece
8140774100	100	10	18	5	
8140774150	150	13	22	5	

# Spannschlösser, Terminals und Drahtseile

## Turnbuckles, terminals and wire ropes

### Tendeurs, ridoirs, embouts à sertir et câbles

# 2

**Sliphaken mit Ring / A4-AISI 316**  
Slip hook with ring / Ridoir pélican avec anneau

## 814167

Bestell-Nr. Order no.	ø	L	B	iD	Box	*€/Stück *€/piece
8141674132 5	5	132	7,1	5,1	5	
8141674142 6	6	142	9,6	6,2	5	
8141674192 8	8	192	11,3	8,5	2	
8141674235 12	12	235	14,4	13,0	2	

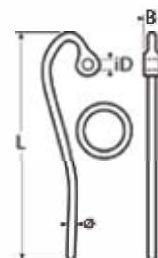

# 2

**Edelstahldrahtseil weich/flexibel 7x19 sZ / A2-AISI 304 / A4-AISI 316**  
Wire rope flexible 7x19 sZ / Câble extra-souple 7x19 sZ

## 8382

Bestell-Nr. A2 Order no. A2	Bestell-Nr. A4 Order no. A4	DS-Ø WR-Ø	**BL kg	Haspellänge m Reel length m	*€/m A2	*€/m A4
83822015100	83824015100	1,5	120	100		
83822015250	83824015250	1,5	120	250		
83822015	83824015	1,5	120	2000		
8382202100	8382402100	2,0	210	100		
8382202250	8382402250	2,0	210	250		
8382202	8382402	2,0	210	2000		
83822025100	83824025100	2,5	330	100		
83822025250	83824025250	2,5	330	250		
83822025	83824025	2,5	330	1000		
8382203100	8382403100	3,0	480	100		
8382203250	8382403250	3,0	480	250		
8382203	8382403	3,0	480	1000		
8382204100	8382404100	4,0	850	100		
8382204250	8382404250	4,0	850	250		
8382204	8382404	4,0	850	1000		
8382205100	8382405100	5,0	1330	100		
8382205250	8382405250	5,0	1330	250		
8382205	8382405	5,0	1330	1000		
8382206100	8382406100	6,0	1910	100		
8382206250	8382406250	6,0	1910	250		
8382206	8382406	6,0	1910	500		
-	8382407250	7,0	2600	250	-	
8382208100	8382408100	8,0	3390	100		
8382208250	8382408250	8,0	3390	250		
8382208	8382408	8,0	3390	500		
-	8382410100	10,0	5310	100	-	
-	8382410250	10,0	5310	250	-	
-	8382410	10,0	5310	500	-	
-	8382412250	12,0	7650	250	-	
-	8382412	12,0	7650	500	-	
-	8382414	14,0	10410	250	-	
-	8382416250	16,0	13600	250	-	

## 7x19

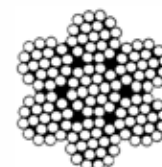

# 2

## Spannschlösser, Terminals und Drahtseile

Turnbuckles, terminals and wire ropes

Tendeurs, ridoirs, embouts à sertir et câbles

8379

Edelstahldrahtseil mittelweich 7x7 sZ / A2-AISI 304 / A4-AISI 316

Wire rope semi-soft 7x7 sZ / Câble souple 7x7 sZ

7x7

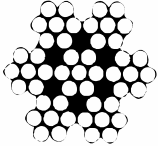

	Bestell-Nr. A2 Order no. A2	Bestell-Nr. A4 Order no. A4	DS-Ø WR-Ø	**BL kg	Haspellänge m Reel length m	*€/m A2	*€/m A4
NEW	8379201100	8379401100	NEW 1,0	60	100		
NEW	8379201250	8379401250	1,0	60	250		
NEW	8379201	8379401	1,0	60	2000		
NEW	83792015100	83794015100	NEW 1,5	130	100		
NEW	83792015250	83794015250	1,5	130	250		
NEW	83792015	83794015	1,5	130	2000		
NEW	8379202100	8379402100	NEW 2,0	230	100		
NEW	8379202250	8379402250	2,0	230	250		
NEW	8379202	8379402	2,0	230	2000		
NEW	83792025100	83794025100	NEW 2,5	360	100		
NEW	83792025250	83794025250	2,5	360	250		
NEW	83792025	83794025	2,5	360	1000		
NEW	8379203100	8379403100	NEW 3,0	510	100		
NEW	8379203250	8379403250	3,0	510	250		
NEW	8379203	8379403	3,0	510	1000		
NEW	8379204100	8379404100	NEW 4,0	910	100		
NEW	8379204250	8379404250	4,0	910	250		
NEW	8379204	8379404	4,0	910	1000		
NEW	8379205100	8379405100	NEW 5,0	1430	100		
NEW	8379205250	8379405250	5,0	1430	250		
NEW	8379205	8379405	5,0	1430	1000		
NEW	8379206100	8379406100	NEW 6,0	2060	100		
NEW	8379206250	8379406250	6,0	2060	250		
NEW	8379206	8379406	6,0	2060	500		
NEW	-	8379407250	7,0	2810	250	-	
NEW	8379208100	8379408100	NEW 8,0	3670	100		
NEW	8379208250	8379408250	8,0	3670	250		
NEW	8379208	8379408	8,0	3670	500		
-	-	8379410100	NEW 10,0	5740	100	-	
-	-	8379410250	10,0	5740	250	-	
-	-	8379410	10,0	5740	500	-	
-	-	8379412250	12,0	8270	250	-	
-	-	8379412	12,0	8270	500	-	

# Spannschlösser, Terminals und Drahtseile

## Turnbuckles, terminals and wire ropes

## Tendeurs, ridoirs, embouts à sertir et câbles

# 2

### Edelstahldrahtseil 7x7 sZ PVC weiß ummantelt / A4-AISI 316

Wire rope 7x7 sZ PVC white coated / Câble souple 7x7 sZ gainé PVC blanc

## 8381

Bestell-Nr. Order no.	DS-Ø WR-Ø	Ø	**BL kg	Haspellänge m Reel length m	*€/m
838143/5250	3	5	510	250	
838144/6250	4	6	910	250	
838144/6	4	6	910	1000	
838144/7250	4	7	910	250	
838144/7	4	7	910	1000	
838145/7250	5	7	1430	250	
838146/9250	6	9	2060	250	



### 7x7

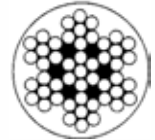

Relingsdrahtset siehe Seite 295.  
Guard rail set see page 295.  
Kit de montage pour filière voir page 295.

### Edelstahldrahtseil 7x7 sZ PVC klar ummantelt / A4-AISI 316

Wire rope 7x7 sZ PVC clear coated / Câble souple 7x7 sZ gainé PVC transparent

## 814593

Bestell-Nr. Order no.	DS-Ø WR-Ø	Ø	**BL kg	Haspellänge m Reel length m	*€/m
81459341/15250	1,0	1,5	60	250	
8145934125/2250	1,25	2,0	90	250	
81459342/3250	2,0	3,0	230	250	
81459343/4250	3,0	4,0	510	250	
81459344/5250	4,0	5,0	910	250	
81459345/7250	5,0	7,0	1430	250	



### 7x7

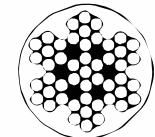

# 2

## Spannschlösser, Terminals und Drahtseile

Turnbuckles, terminals and wire ropes

Tendeurs, ridoirs, embouts à sertir et câbles

8378

Edelstahldrahtseil hart/steif 1x19 sZ / A4-AISI 316

Wire rope hard/stiff 1x19 sZ / Câble rigide 1x19 sZ

1x19



Bestell-Nr. Order no.	DS-Ø WR-Ø	**BL kg	Haspellänge m Reel length m	*€/m
8378401250	1,0	80	250	
8378401	1,0	80	2000	
83784015250	1,5	180	250	
83784015	1,5	180	2000	
8378402250	2,0	330	250	
8378402	2,0	330	2000	
83784025250	2,5	520	250	
83784025	2,5	520	1000	
8378403250	3,0	750	250	
8378403	3,0	750	1000	
8378404250	4,0	1340	250	
8378404	4,0	1340	1000	
8378405250	5,0	2100	250	
8378405	5,0	2100	1000	
8378406250	6,0	3020	250	
8378406	6,0	3020	500	
8378407250	7,0	4120	250	
8378408250	8,0	5380	250	
8378408	8,0	5380	500	
8378410250	10,0	8400	250	
8378412250	12,0	12100	500	
8378412	12,0	12100	250	

814931

Drahtseil steif/hart 1x19 sZ, made in Korea / A4-AISI 316

Wire rope hard/stiff 1x19 sZ, made in korea / Câble rigide 1x19 sZ, fabriqué en corée

**NEW**

1x19



Made in Korea



Bestell-Nr. Order no.	DS-Ø WR-Ø	**BL kg	Haspellänge m Reel length m	*€/m
814931402250	2,0	330	250	
8149314025250	2,5	520	250	
814931403250	3,0	750	250	
814931404250	4,0	1340	250	
814931405250	5,0	2100	250	
814931406250	6,0	3020	250	
814931407100	7,0	4120	100	
814931407250	7,0	4120	250	
814931408100	8,0	5380	100	
814931408250	8,0	5380	250	
814931410100	10,0	8400	100	
814931410250	10,0	8400	250	
814931412100	12,0	12100	100	
814931412250	12,0	12100	250	

# Spannschlösser, Terminals und Drahtseile

## Turnbuckles, terminals and wire ropes

### Tendeurs, ridoirs, embouts à sertir et câbles

# 2

## NEW

**Drahtseil-Set / A4-AISI 316**  
Wire rope set / Kit de câble

**814979**

**Drahtseil-ø: 2 mm / Wire rope-ø: 2 mm / Kit de câble-ø: 2 mm**

Bestell-Nr. Order no.	Set	Länge Lenght	Kausche Thimble	Duplexklemme Duplex clip	Spannschloss Turnbuckle	Box	*€/Stück *€/piece
81497942-010	S	10 m	4 x	4 x	2 x M4	1	
81497942-025	M	25 m	10 x	10 x	5 x M4	1	
81497942-050	L	50 m	20 x	20 x	10 x M4	1	
81497942-250	XL*	250 m	50 x	50 x	25 x M4	1	

**Drahtseil-ø: 3 mm / Wire rope-ø: 3 mm / Kit de câble-ø: 3 mm**

Bestell-Nr. Order no.	Set	Länge Lenght	Kausche Thimble	Duplexklemme Duplex clip	Spannschloss Turnbuckle	Box	*€/Stück *€/piece
81497943-010	S	10 m	4 x	4 x	2 x M6	1	
81497943-025	M	25 m	10 x	10 x	5 x M6	1	
81497943-050	L	50 m	20 x	20 x	10 x M6	1	
81497943-200	XL*	200 m	50 x	50 x	25 x M6	1	

**Drahtseil-ø: 4 mm / Wire rope-ø: 4 mm / Kit de câble-ø: 4 mm**

Bestell-Nr. Order no.	Set	Länge Lenght	Kausche Thimble	Duplexklemme Duplex clip	Spannschloss Turnbuckle	Box	*€/Stück *€/piece
81497944-010	S	10 m	4 x	4 x	2 x M8	1	
81497944-025	M	25 m	10 x	10 x	5 x M8	1	
81497944-050	L	50 m	20 x	20 x	10 x M8	1	
81497944-150	XL*	150 m	50 x	50 x	25 x M8	1	



+



**\*Set XL**

inkl. KNIPEX® Drahtseilschere

Incl. KNIPEX® wire rope cutter

Incl. cisaille pour câble KNIPEX®



# 2

## Spannschlösser, Terminals und Drahtseile

Turnbuckles, terminals and wire ropes

Tendeurs, ridoirs, embouts à sertir et câbles

### 8247

Kausche / A4-AISI 316  
Thimble / Cosse cœur

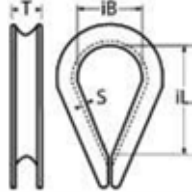

Bestell-Nr. Order no.	DS-Ø WR-Ø	iL	iB	S	T	Box	*€/Stück *€/piece
8247402	2,0	10	7	0,7	4,0	50	
82474025	2,5	14	8	0,7	4,5	50	
8247403	3,0	15	9	1,0	5,5	50	
8247404	4,0	18	11	1,0	6,0	20	
8247405	5,0	20	14	1,2	7,5	20	
8247406	6,0	26	15	1,2	9,0	20	
<b>NEW</b> 8247407	7,0	27	15	1,2	10,0	10	
8247408	8,0	29	18	1,5	12,0	10	
8247410	10,0	37	24	1,5	14,5	10	
8247412	12,0	50	29	1,5	18,0	10	
8247414	14,0	54	33	2,0	21,0	5	
8247416	16,0	64	37	2,0	23,0	5	
8247418	18,0	70	40	2,5	24,0	1	
8247420	20,0	75	45	2,5	28,0	1	
8247422	22,0	88	53	2,5	33,0	1	
8247424	24,0	92	58	3,0	33,0	1	

### 8536

Kausche, schwere Ausführung / A4-AISI 316  
Thimble, heavy duty / Cosse cœur arrondie

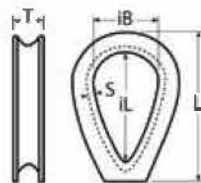

Bestell-Nr. Order no.	DS-Ø WR-Ø	L	iL	iB	T	S	Box	*€/Stück *€/piece
8536402	2	21	15	9	5	1,6	10	
8536403	3	26	18	11	6	2,0	10	
8536404	4	32	21	14	7	3,0	10	
8536405	5	42	28	15	9	4,5	10	
8536406	6	43	28	17	11	2,6	10	
8536408	8	58	43	24	10	3,2	5	
8536410	10	68	51	28	13	5,0	5	
8536412	12	86	62	37	16	5,0	5	
<b>NEW</b> 8536414	14	100	74	39	19	8,5	1	
8536416	16	110	82	47	20	6,5	1	
8536419	19	124	94	60	24	4,5	1	
8536422	22	126	100	63	28	5,5	1	
8536425	25	146	115	74	32	6,0	1	

# Spannschlösser, Terminals und Drahtseile

## Turnbuckles, terminals and wire ropes

### Tendeurs, ridoirs, embouts à sertir et câbles

# 2

**Kausche mit Steg / A4-AISI 316**  
Thimble with bar / Cosse-cœur renfort soudé

## 8636

Bestell-Nr. Order no.	DS-Ø WR-Ø	L	iL	iB	S	T	Box	*€/Stück *€/piece
8636406	6	37	11	14	1,2	11,5	10	
8636408	8	50	15	19	1,5	13,5	10	
8636410	10	53	21	26	2,0	14,5	10	
8636412	12	60	25	27	2,5	16,0	5	
8636414	14	74	30	34	2,5	19,0	5	
8636416	16	83	30	40	2,5	23,0	1	
8636418	18	92	32	41	2,0	25,0	1	
8636420	20	104	35	46	2,0	28,0	1	

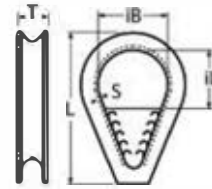

NEW  
NEW  
NEW

**Nylon Kausche / Nylon**  
Nylon thimble / Cosse cœur en nylon

## 814453

Bestell-Nr. Order no.	Für Seil-Ø For rope-Ø	iL	iB	T	S	Box	*€/Stück *€/piece
814453304	4	19	13	7	2	20	
814453306	6	22	16	8	2	20	
814453308	8	38	23	10	2	20	
814453310	10	40	24	13	3	10	
814453312	12	41	24	15	3	10	
814453314	14	44	26	17	3	10	
814453316	16	54	34	19	5	5	
814453318	18	56	34	21	6	5	
814453320	20	57	35	25	6	5	

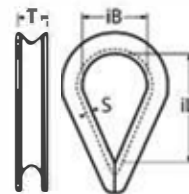

**Gleistein Ropes**  
The Perfect Line

**Alu-Rundkausche mit/ohne gespleißter Schlaufe / Alu / PE**  
Alu low friction ring with/without spliced loop / Anneau en aluminium avec/sans boucle de corde

## 814984

Bestell-Nr. Order no.	(Für) Seil-Ø (For) rope-Ø	iL	iD	D	B	**BL kg	Box	*€/Stück *€/piece
814984005LOOP	*4	100	7	18	9	660	2	
814984005	5	—	7	18	9	1220	5	
814984007LOOP	*6	130	10	25	12	1280	2	
814984007	7	—	10	25	12	2030	5	
814984010LOOP	*9	160	14	35	15	3000	1	
814984010	10	—	14	35	15	3000	2	
814984014LOOP	*12	220	20	50	22	5500	1	
814984014	14	—	20	50	22	5500	2	



LOOP



NEW

\*Schlaufe/Tauwerk aus HMPE von Gleistein

\*Loop/rope made of HMPE from Gleistein

\*Boucle de corde en HMPE de Gleistein

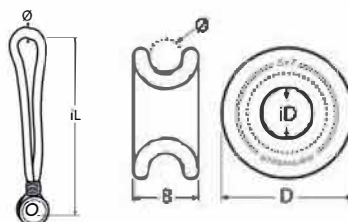

# 2

## Spannschlösser, Terminals und Drahtseile

Turnbuckles, terminals and wire ropes

Tendeurs, ridoirs, embouts à sertir et câbles

### 8248

**Drahtseilklemme / A4-AISI 316**

Wire rope clip / Serre-câble étrier

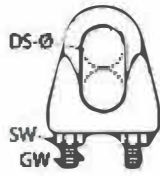

**NEW**

Bestell-Nr. Order no.	DS-Ø WR-Ø	GW	Antrieb Drive	Box	*€/Stück *€/piece
8248402	2	M3	SW5,5	50	
8248403	3	M3	SW5,5	50	
8248404	4	M4	SW7	20	
8248405	5	M5	SW8	20	
8248406	6	M6	SW10	20	
8248408	8	M6	SW10	10	
8248410	10	M8	SW13	10	
8248412	12	M10	SW17	5	
8248413	13	M10	SW17	5	
8248416	16	M10	SW17	5	
8248418	18	M12	SW19	1	
8248422	22	M12	SW19	1	

### 814391

**Eiform Drahtseilklemme / A4-AISI 316**

Egg shaped wire rope clip / Serre-câble œuf

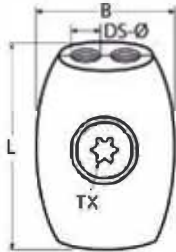

Bestell-Nr. Order no.	DS-Ø WR-Ø	GW	L	B	Antrieb Drive	Box	*€/Stück *€/piece
814391402	2	M5	28	15	TX25	10	
814391403	3	M5	28	15	TX25	10	
814391404	4	M6	34	19	TX30	10	
814391405	5	M6	34	20	TX30	5	
814391406	6	M6	35	24	TX30	5	

### 8304

**Simplex Drahtseilklemme / A4-AISI 316**

Simplex wire rope clip / Serre-câble plat simple

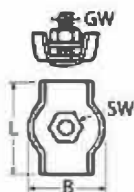

Bestell-Nr. Order no.	DS-Ø WR-Ø	GW	L	B	Antrieb Drive	Box	*€/Stück *€/piece
8304402	2	M4	15	11,5	SW7	20	
8304403	3	M4	18	14,5	SW7	20	
8304404	4	M5	20	16,5	SW8	20	
8304405	5	M5	24	20,0	SW8	10	
8304406	6	M6	29	24,5	SW10	10	
8304408	8	M8	35	31,5	SW13	5	
8304410	10	M10	48	38,0	SW17	5	

# Spannschlösser, Terminals und Drahtseile

Turnbuckles, terminals and wire ropes  
Tendeurs, ridoirs, embouts à sertir et câbles

# 2

## Duplex Drahtseilklemme / A4-AISI 316 Duplex wire rope clip / Serre-câble plat double

### 8284

Bestell-Nr. Order no.	DS-Ø WR-Ø	GW	L	B	Antrieb Drive	Box	*€/Stück *€/piece
8284402	2	M4	33	11,5	SW7	20	
8284403	3	M4	38	14,5	SW7	20	
8284404	4	M5	43	16,5	SW8	20	
8284405	5	M5	51	20,0	SW8	10	
8284406	6	M6	63	24,5	SW10	10	
8284408	8	M8	78	31,5	SW13	5	
8284410	10	M10	85	38,0	SW17	5	

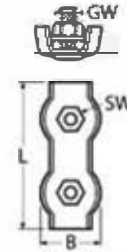

## Klemmstopper / A4-AISI 316 Wire rope stopper / Bague d'arrêt pour câble

### 814722

Bestell-Nr. Order no.	DS-Ø WR-Ø	GW	L	D	Antrieb Drive	Box	*€/Stück *€/piece
814722402	2	M4	8	10	SW2	10	
814722403	3	M6	12	15	SW3	10	
814722404	4	M8	12	15	SW4	10	
814722405	5	M10	15	20	SW5	10	
814722406	6	M10	15	20	SW5	10	

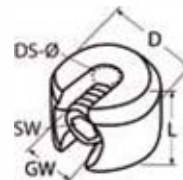

## Kreuzklemme mit Sackgewinde / A4-AISI 316 Wire rope cross clip with blind thread / Serre-câble croisé fond fermé

### 8424

Bestell-Nr. Order no.	DS-Ø WR-Ø	GW	L	D	Antrieb Drive	Box	*€/Stück *€/piece
842443	3	M12	19	20	SW6	10	
842444	4	M12	21	20	SW6	10	
842445	5	M12	23	20	SW6	5	
842446	6	M12	25	20	SW6	5	

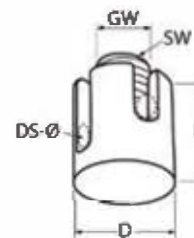

## Kreuzklemme mit Durchgangsgewinde / A4-AISI 316 Wire rope cross clip with through-hole thread / Serre-câble croisé fond ouvert

### 814817

Bestell-Nr. Order no.	DS-Ø WR-Ø	GW	L	D	Antrieb Drive	Box	*€/Stück *€/piece
81481743	3	M10	19	17	SW5	10	
81481744	4	M12	21	20	SW6	10	
81481745	5	M12	23	20	SW6	5	



# 2

## Spannschlösser, Terminals und Drahtseile

Turnbuckles, terminals and wire ropes

Tendeurs, ridoirs, embouts à sertir et câbles

### 814700

**Klemmring 2-tlg. mit 2 Schrauben / A4-AISI 316**

2-part clamping ring with 2 screws / Bague d'arrêt pour câble, 2 parties (2 vis)

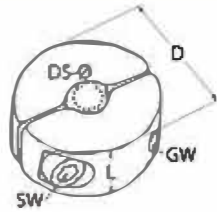

Bestell-Nr. Order no.	DS-Ø WR-Ø	GW	L	D	Antrieb Drive	Box	*€/Stück *€/piece
814700402	2	M3	10	15	SW2,5	10	
814700403	3	M3	10	15	SW2,5	10	
814700404	4	M3	10	15	SW2,5	10	
814700405	5	M3	10	20	SW2,5	10	
814700406	6	M3	10	20	SW2,5	10	
814700408	8	M4	12	20	SW3	10	

### 814701

**Klemmring 2-tlg. mit 4 Schrauben / A4-AISI 316**

2-part clamping ring with 4 screws / Bague d'arrêt pour câble, 2 parties (4 vis)

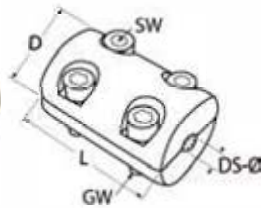

Bestell-Nr. Order no.	DS-Ø WR-Ø	GW	L	D	Antrieb Drive	Box	*€/Stück *€/piece
814701403	3	M4	27	22	SW3	5	
814701404	4	M4	27	22	SW3	5	
814701405	5	M5	42	28	SW4	2	
814701406	6	M5	42	28	SW4	2	
814701408	8	M5	42	28	SW4	2	

### 8470

**Pressklemme Edelstahl / A4-AISI 316**

Stainless steel ferrule / Manchon en inox

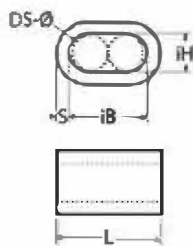

Bestell-Nr. Order no.	DS-Ø WR-Ø	Klemmgröße Crimp size	iH	iB	S	L	Box	*€/Stück *€/piece
8470401	1,0	1,0	1,2	2,4	0,65	5	10	
84704015	1,5	1,5	1,7	3,4	0,85	6	10	
8470402	2,0	2,0	2,5	4,5	1,0	7	10	
84704025	2,5	2,5	2,7	5,4	1,0	9	10	
8470403	3,0	3,0	3,5	7,5	1,0	11	10	
8470404	4,0	4,0	4,5	9,2	1,5	14	10	
8470405	5,0	5,0	5,6	11,5	2,0	18	10	
8470406	6,0	6,0	6,8	13,5	2,5	21	10	
8470407	7,0	7,0	8,0	16,5	2,5	25	5	
8470408	8,0	8,0	9,0	18,0	3,0	28	5	
8470410	10,0	10,0	11,5	22,5	3,2	35	1	
8470412	12,0	12,0	14,2	28,5	4,0	42	1	

# Spannschlösser, Terminals und Drahtseile

## Turnbuckles, terminals and wire ropes

### Tendeurs, ridoirs, embouts à sertir et câbles

# 2

**Pressklemme Kupfer / CU**  
Copper ferrule / Manchon en cuivre

## 8285

Bestell-Nr. Order no.	DS-Ø WR-Ø	Klemmgröße Crimp size	iH	iB	S	L	Box	*€/Stück *€/piece
8285101	1,0	1,5	1,7	3,4	0,75	6	100	
82851015	1,5	2,0	2,4	4,8	0,85	7	100	
8285102	2,0	2,5	2,7	5,4	1,05	9	100	
82851025	2,5	3,0	3,3	6,6	1,25	11	100	
8285103	3,0	3,5	3,8	7,6	1,5	13	100	
8285104	4,0	4,5	4,9	9,8	1,9	16	100	
8285105	5,0	6,0	6,6	13,2	2,5	21	50	
8285106	6,0	6,5	7,2	14,4	2,7	23	50	
8285107	7,0	8,0	8,8	17,6	3,3	28	10	
8285108	8,0	9,0	9,9	19,8	3,7	32	10	
8285110	10,0	11,0	12,1	24,2	4,5	39	10	
8285112	12,0	13,0	14,2	28,4	5,4	46	10	
8285116	16,0	18,0	19,6	39,2	7,6	63	5	

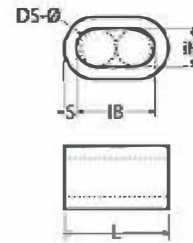

# 2

## NEW

**Pressklemme Kupfer verzinkt / Cu vz**  
Copper ferrule tinned / Manchon en cuivre étamé

## 8285

Bestell-Nr. Order no.	DS-Ø WR-Ø	Klemmgröße Crimp size	iH	iB	S	L	Box	*€/Stück *€/piece
8285101VZ	1,0	1,5	1,7	3,4	0,75	6	100	
82851015VZ	1,5	2,0	2,4	4,8	0,85	7	100	
8285102VZ	2,0	2,5	2,7	5,4	1,05	9	100	
8285103VZ	3,0	3,5	3,8	7,6	1,5	13	100	
8285104VZ	4,0	4,5	4,9	9,8	1,9	16	100	
8285105VZ	5,0	6,0	6,6	13,2	2,5	21	50	
8285106VZ	6,0	6,5	7,2	14,4	2,7	23	50	
8285108VZ	8,0	9,0	9,9	19,8	3,7	32	10	

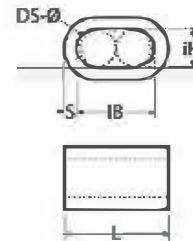

Kupfer-Pressklemmen mit einer verzinnnten Oberflächenbeschichtung sehen in Verbindung mit silbernem Drahtseil oder anhängenden Beschlägen nicht nur optisch ansprechender aus (auch nach der Verarbeitung!). Die Beschichtung bewirkt einen zusätzlichen Korrosionsschutz und verhindert die nachträgliche Bildung einer grünlichen Patina bzw. Passivschicht des Kupfers nach Berührung mit leicht aggressiven Laugen und Säuren.

Copper ferrules with a tinned coating in combination with silver wire rope or fittings are not only visually looking better (even after processing!). The coating additionally prevents the formation of green patina or passive layer of the copper in contact with lower aggressive alkalis or acids.

Les manchons en cuivre avec revêtement superficiel étamé sont très attrayants en conjonction avec un câble inox argenté ou des raccords (même après la fabrication). Également, le revêtement offre une protection anticorrosion et empêche la formation d'une patine verdâtre ultérieure ou bien d'une couche passive de cuivre au contact d'alcalins et d'acides légèrement agressifs.



# 2

## Spannschlösser, Terminals und Drahtseile

Turnbuckles, terminals and wire ropes

Tendeurs, ridoirs, embouts à sertir et câbles

8471

Pressklemme Aluminium / Alu

Alu ferrule / Manchon en alu

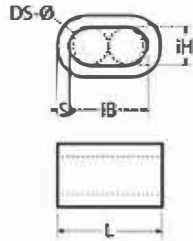

Bestell-Nr. Order no.	DS-Ø WR-Ø	Klemmgröße Crimp size	iH	iB	S	L	Box	*€/Stück *€/piece
8471001	1,0	1,5	1,7	3,4	0,75	6	100	
84710015	1,5	2,0	2,4	4,8	0,85	7	100	
8471002	2,0	2,5	2,7	5,4	1,05	9	100	
84710025	2,5	3,0	3,3	6,6	1,25	11	100	
8471003	3,0	3,5	3,8	7,6	1,5	13	100	
8471004	4,0	4,5	4,9	9,8	1,9	16	100	
8471005	5,0	6,0	6,6	13,2	2,5	21	50	
8471006	6,0	6,5	7,2	14,4	2,7	23	50	
8471007	7,0	8,0	8,8	17,6	3,3	28	10	
8471008	8,0	9,0	9,9	19,8	3,7	32	10	
8471010	10,0	11,0	12,1	24,2	4,5	39	10	
8471012	12,0	13,0	14,2	28,4	5,4	46	5	

815001

Drahtseilklemme mit Auge, MT-Serie / A4-AISI 316

Wire rope clip with eye, MT series / Serre-câbles avec œil, Série MT



NEW

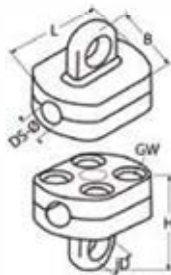

Bestell-Nr. Order no.	DS-Ø WR-Ø	L	B	H	iD	GW	Box	*€/Stück *€/piece
815001408	8	45	35	39	12	M5	1	
815001410	10	45	35	39	12	M5	1	

815002

Drahtseilklampe, MT-Serie / A4-AISI 316

Cleat for wire rope, MT series / Taquet pour câble, Série MT



NEW

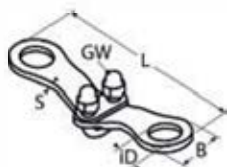

Bestell-Nr. Order no.	DS-Ø WR-Ø	L	B	iD	S	GW	Box	*€/Stück *€/piece
8150024110	8+10	110	30	16	3	M6	1	

# Spannschlösser, Terminals und Drahtseile

Turnbuckles, terminals and wire ropes  
Tendeurs, ridoirs, embouts à sertir et câbles

# 2

Steckbolzen / A4-AISI 316  
Clevis pin / Axe pour ridoir

## 8279

Bestell-Nr. Order no.	ø	L1	L2	iD	Box	*€/Stück *€/piece
8279404 14	4	14	11	2,0	5	
8279404 20	4	20	16	2,0	5	
8279405 15	5	15	11	2,5	5	
8279405 18	5	18	14	2,5	5	
8279405 21	5	21	17	2,5	5	
8279406 15	6	15	11	2,5	5	
8279406 20	6	20	16	2,5	5	
8279406 24	6	24	20	2,5	5	
8279406 25	6	25	21	2,5	5	
8279406 29	6	29	25	2,5	5	
8279406 34	6	34	30	2,5	5	
8279406 36	6	36	32	2,5	5	
8279406 44	6	44	40	2,5	5	
8279406 45	6	45	41	2,5	5	
8279406 54	6	54	50	2,5	5	
8279406 64	6	64	60	2,5	5	
8279408 21	8	21	17	3,0	2	
8279408 24	8	24	20	3,0	2	
8279408 27	8	27	23	3,0	2	
8279408 32	8	32	28	3,0	2	
8279408 34	8	34	30	3,0	2	
8279408 44	8	44	40	3,0	2	
8279408 54	8	54	50	3,0	2	
8279408 64	8	64	60	3,0	2	
8279408 74	8	74	70	3,0	2	
8279408 84	8	84	80	3,0	2	
82794095 26	9,5	26	22	3,0	1	
82794095 30	9,5	30	26	3,0	1	
8279410 34	10	34	30	3,0	1	
8279410 44	10	44	40	3,0	1	
8279410 54	10	54	50	3,0	1	
8279410 64	10	64	60	3,0	1	
8279410 74	10	74	70	3,0	1	
8279410 84	10	84	80	3,0	1	
8279410 94	10	94	90	3,0	1	
8279410 104	10	104	100	3,0	1	
8279411 29	11	29	25	3,0	1	
8279412 30	12	30	26	3,0	1	
8279412 45	12	45	40	3,0	1	
8279412 55	12	55	50	3,0	1	
8279412 65	12	65	60	3,0	1	
8279412 75	12	75	70	3,0	1	
8279412 85	12	85	80	3,0	1	
8279412 95	12	95	90	3,0	1	
8279412 105	12	105	100	3,0	1	
8279412 115	12	115	110	3,0	1	
8279412 125	12	125	120	3,0	1	
8279414 41	14	41	36	4,0	1	

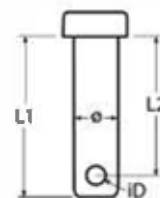

# 2

# 2

## Spannschlösser, Terminals und Drahtseile

Turnbuckles, terminals and wire ropes

Tendeurs, ridoirs, embouts à sertir et câbles

### 8356

**Klappnasenbolzen / A2-AISI 304**

Drop nose pin / Axe pour ridoir avec languette



Bestell-Nr. Order no.	ø	L	L1	Box	*€/Stück *€/piece
8356206 20	6	20	12	5	
8356206 26	6	26	18	5	
8356206 31	6	31	23	5	
8356206 56	6	56	48	5	
8356206 65	6	65	57	5	
8356208 28	8	28	20	2	
8356208 34	8	34	25	2	
8356208 38	8	38	30	2	
8356208 43	8	43	35	2	
8356210 35	10	35	25	1	
8356210 45	10	45	35	1	
8356210 55	10	55	45	1	

### 815014

**Klappnasenbolzen, MT-Serie, made in Germany / A5-AISI 316 Ti**

Drop nose pin, MT series / Axe pour ridoir avec languette, Série MT



## NEW

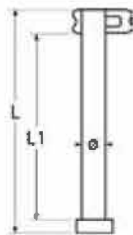

Bestell-Nr. Order no.	ø	L	L1	Box	*€/Stück *€/piece
815014406 20	6	20	12	5	
815014406 26	6	26	18	5	
815014406 31	6	31	23	5	
815014406 56	6	56	48	5	
815014406 65	6	65	57	5	
815014408 30	8	30	20	2	
815014408 35	8	35	25	2	
815014408 40	8	40	30	2	
815014408 45	8	45	35	2	
815014410 37	10	37	25	1	
815014410 47	10	47	35	1	
815014410 57	10	57	45	1	

# Spannschlösser, Terminals und Drahtseile

Turnbuckles, terminals and wire ropes  
Tendeurs, ridoirs, embouts à sertir et câbles

# 2

## Steckbolzen mit Kugelsicherung / A2-AISI 304

Pin with ball lock / Goupille à bille

### 8474

Bestell-Nr. Order no.	∅	L	L1	Box	*€/Stück *€/piece
847425 28	5,0	28	13	10	
847426 35	6,3	35	22	10	
847428 33	8,0	33	22	5	
847428 53	8,0	53	38	5	



## Steckbolzen mit manueller Kugelsicherung / A2-AISI 304

Quick release pin with manual ball lock / Goupille à bille manuelle

### 814729

Bestell-Nr. Order no.	∅	L	L1	D	Box	*€/Stück *€/piece
814729206 25	6	55	25	20	1	
814729206 40	6	70	40	20	1	
814729208 25	8	55	25	20	1	
814729208 40	8	70	40	20	1	
814729210 25	10	60	25	25	1	
814729210 40	10	75	40	25	1	



## Klappsplint mit Ring / A4-AISI 316

Linch pin / Goupille clip

### 814076

Bestell-Nr. Order no.	∅	∅1	L	L1	iD	Box	*€/Stück *€/piece
8140764440	4,4	2,4	49,6	35	39,0	10	
8140764600	6,0	3,2	56,2	39	44,8	10	
8140764790	7,4	3,1	56,5	39	44,9	5	
8140764106	10,6	3,2	56,5	39	43,4	5	

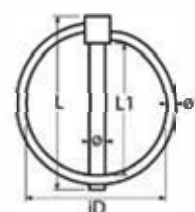

## Federstecker / A4-AISI 316

Spring cotter / Goupille beta

### 8273

Bestell-Nr. Order no.	∅	L	Box	*€/Stück *€/piece
827342	2,0	49	50	
8273425	2,5	55	50	
827343	3,0	70	50	
827344	4,0	79	20	
827345	5,0	101	20	
827346	6,0	126	10	

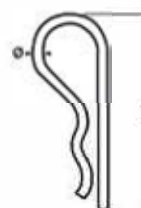

# 2

## Spannschlösser, Terminals und Drahtseile

Turnbuckles, terminals and wire ropes

Tendeurs, ridoirs, embouts à sertir et câbles

### 8431

**Federstecker ähnl. DIN 11024 / A4-AISI 316**

Spring cotter similar to DIN 11024 / Goupille beta double similaire à DIN 11024

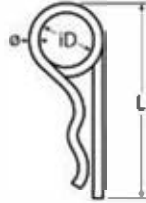

Bestell-Nr. Order no.	ø	L	iD	Box	*€/Stück *€/piece
8431425	2,25	54	20	10	
8431432	2,8	61	20	10	
8431440	3,6	78	20	10	
8431450	4,5	97	25	5	
8431463	5,6	115	25	5	
8431470	6,3	146	30	1	
8431480	7,0	172	30	1	

### 814911

**Fokkernadel / A4-AISI 316**

Safety spring / Épingle de sécurité

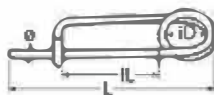

Bestell-Nr. Order no.	ø	L	iL	iD	Box	*€/Stück *€/piece
814911402	2	60	32	12	10	
814911403	3	80	40	16	10	
814911404	4	100	48	20	10	

### 8383

**Ringsplint / A4-AISI 316**

Ring pin / Anneau brisé

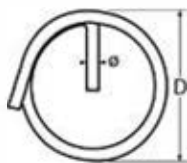

Bestell-Nr. Order no.	ø	D	Für Steckbolzen-Ø For clevis pin-Ø	Box	*€/Stück *€/piece
8383410 10	1,0	10	4	50	
8383412 15	1,2	15	5 - 6	50	
8383415 20	1,5	20	8 - 10	20	
8383418 25	1,8	25	11 - 14	20	

### 8358

**Sicherungsring / A2-AISI 304**

Cotter ring / Anneau de sécurité

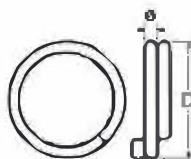

Bestell-Nr. Order no.	ø	D	Box	*€/Stück *€/piece
8358210	1,5	10	50	
8358216	1,5	16	50	
8358218	1,5	18	50	
8358222	1,5	22	50	
8358226	1,5	26	50	
8358230	1,5	30	50	

# Spannschlösser, Terminals und Drahtseile

Turnbuckles, terminals and wire ropes  
Tendeurs, ridoirs, embouts à sertir et câbles

# 2

## Sicherungsseil PVC transparent ummantelt / A2-AISI 304 / PVC Security wire rope PVC clear coated / Câble de sécurité

### 8719

Bestell-Nr. Order no.	DS-Ø WR-Ø	L	iD	iD1	Box	*€/Stück *€/piece
87192200	1,2	145	5,4	8	10	

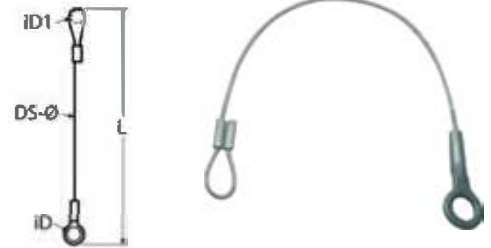

## Sicherungsseil mit Steckbolzen / A2-AISI 304 Security wire with ball lock pin / Câble de sécurité avec goupille à bille

### 8590

Bestell-Nr. Order no.	DS-Ø WR-Ø	ø	L	B	S	BD	Box	*€/Stück *€/piece
859026 25	1,0	6,3	250	13	1,5	5,2	10	

Länge kann um +/- 20% variieren.  
Length can vary +/- 20%.  
La longueur peut varier +/- 20%.



## NEW

## Sicherungsseil mit Klappnasenbolzen / A2-AISI 304 Security wire with drop nose pin / Câble de sécurité avec axe à languette

### 814996

Bestell-Nr. Order no.	DS-Ø WR-Ø	ø	L	B	S	BD	Box	*€/Stück *€/piece
8149964255	1,0	6	255	13	1,2	5	10	



## Drahtseilschere / Stahl gehärtet Wire rope cutter / Cisaille pour câble

### 8504

Bestell-Nr. Order no.	DS-Ø WR-Ø	L	Box	*€/Stück *€/piece
85041004	4*	195	1	
85041012	12	470	1	
85041016	16	800	1	
850410ERSATZ12	Ersatzmesser für 12 / Replacement blade for 12		1	
850410ERSATZ16	Ersatzmesser für 16 / Replacement blade for 16		1	

\* max. 4mm 7x19 + 7x7  
max. 3mm 1x19



850410ERSATZ12  
850410ERSATZ16



85041004



85041012 + 85041016



# 2

## Spannschlösser, Terminals und Drahtseile

Turnbuckles, terminals and wire ropes

Tendeurs, ridoirs, embouts à sertir et câbles

### 814678

**Hydraulische Presszange, 12t / Stahl**

Hydraulic crimping tool 12t / Pince hydraulique à sertissage manuel



Bestell-Nr. Order no.	Max. Presskraft Max. pressing force	L	Box	*€/Stück *€/piece
8146781012	12 Tonnen / 12 tons	480	1	

Mit einer Kraft von 12 Tonnen und einer Werkzeugbreite von 12mm ist die hydraulische Presszange optimal geeignet um Terminals und Oval-Presshül-sen schnell und kostengünstig direkt vor Ort zu verpressen. Lieferung im Kunststoffkoffer ohne Presseinsätze.

With a force of 12 tons and a width of 12mm, the hydraulic crimping tool is ideally suited for quickly and inexpensively crimping for terminals and ferrules directly on site. Supplied in a plastic case without crimping dies.

Avec une force de 12 tonnes et une largeur d'outil de 12mm, la pince hydrolique convient parfaitement aux terminaisons et manchons pour presser rapidement et à moindre coût directement sur place. Livraison en coffret plastique sans machoirs.

### 814679

**Pressbacken für Terminals / Stahl gehärtet**

Dies for terminal crimping / Machoir pour terminaison



Bestell-Nr. Order no.	DS-Ø WR-Ø	Terminal Außen-Ø Terminal outside-Ø	Box	*€/Stück *€/piece
81467912-025	2,0/2,5	5,5	1	
81467912-03	3,0	6,4	1	
81467912-04	4,0	7,5	1	
81467912-05	5,0	9,0	1	
81467912-06	6,0	12,5	1	

Für Artikel 814678.

Gefertigt aus hochwertigem Werkzeugstahl mit optimaler Härte und Zähigkeit. Qualität made in Germany gewährleistet maximale Lebensdauer.

For article 814678.

Made from high quality tool steel with optimum hardness and toughness. Quality made in Germany ensures maximum durability.

Pour article 814678.

Fabriqué en acier à outils de haute qualité avec une dureté et une ténacité optimales. La qualité made in Germany garantit une durée de vie maximale.

### 814810

**Pressbacken für Oval-Pressklemmen / Stahl gehärtet**

Dies for oval-ferrules crimping / Mâchoires pour manchon ovale



Abb. 81481012-01



Abb. 81481012-025

Abb. 81481012-04

Bestell-Nr. Order no.	DS-Ø WR-Ø	Pressbreite Pressing width	Box	*€/Stück *€/piece
81481012-01	1,0 / 1,5 / 2,0	12	1	
<b>NEW</b> 81481012-025	2,5	12	1	
81481012-03	3,0	12	1	
81481012-04	4,0	12	1	
<b>NEW</b> 81481012-05	5,0	4	1	

Für Artikel 814678

Drahtseildurchmesser (DS-Ø) gültig für Drahtseile mit Stahleinlage (SE). Nicht für Pressklemmen aus Edelstahl geeignet.

For article 814678

Wire rope diameter (DS-Ø) only for wire ropes with wire core (WC). Not usable for stainless steel ferrules.

Pour article 814678.

Diamètre de câble (DS-Ø) valable pour les câbles avec âme en acier. Ne convient pas pour les manchons en acier inoxydable.



AAbb. 81481012-05

# Spannschlösser, Terminals und Drahtseile

## Turnbuckles, terminals and wire ropes

## Tendeurs, ridoirs, embouts à sertir et câbles

# 2

### Stockschraube mit Rechtsgewinde / A4-AISI 316

Dowel screw with right thread / Goujon avec filetage à droite

## 8515

Bestell-Nr. Order no.	GW	L	L1	L2	Antrieb Drive	Box	*€/Stück *€/piece
8515405	M5	80	43	32	SW3	5	
8515406	M6	90	50	35	SW4	5	
8515408	M8	130	65	55	SW5	5	
8515410	M10	150	75	55	SW7	5	

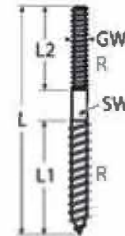

# 2

### Stockschraube mit Linksgewinde / A4-AISI 316

Dowel screw with left thread / Goujon avec filetage à gauche

## 8516

Bestell-Nr. Order no.	GW	L	L1	L2	Antrieb Drive	Box	*€/Stück *€/piece
8516405	M5L	80	43	32	SW3	5	
8516406	M6L	90	50	35	SW4	5	
8516408	M8L	130	65	55	SW5	5	
8516410	M10L	150	75	55	SW7	5	

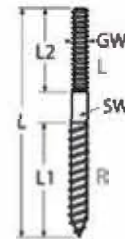

### Massivkugel mit Innengewinde, blank / A2-AISI 304

Massive ball with internal thread, machined / Boule massive mate avec filetage interne

## 8462

Bestell-Nr. Order no.	GW	iL	D	Box	*€/Stück *€/piece
8462215	M6	6	15	10	
8462220	M6	17	20	10	
8462225	M6	17	25	10	
8462230	M6	18	30	10	
8462240	M8	24	40	5	
8462250	M8	24	50	5	

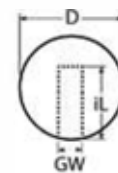

# 2

## Spannschlösser, Terminals und Drahtseile

Turnbuckles, terminals and wire ropes

Tendeurs, ridoirs, embouts à sertir et câbles

### 8463

**Massivkugel mit Innengewinde, poliert / A2-AISI 304**

Massive ball with internal thread, polished / Boule massive polie avec filetage interne

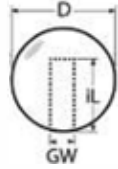

Bestell-Nr. Order no.	GW	iL	D	Box	*€/Stück *€/piece
8463215	M6	6	15	10	
8463220	M6	17	20	10	
8463225	M6	17	25	10	
8463230	M6	18	30	10	
8463240	M6	24	40	5	
8463250	M8	24	50	5	

### 8499

**Kombi-Wandkonsole / A4-AISI 316**

Combi wall bracket / Support mural



Bestell-Nr. Order no.	GW	A	B	BD	H1	H2	H3	D	iD	iD1	S	Box	*€/Stück *€/piece
8499A135 90	M4	135	25	10	90	69	14	16	8	8	4	1	
8499B135 90	-	135	25	10	90	-	-	-	9	-	4	1	

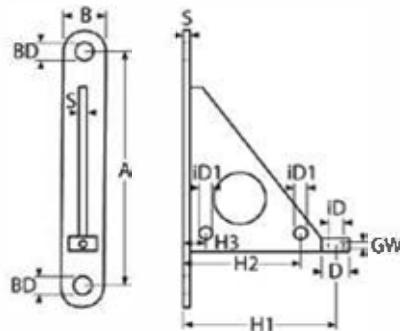

8499A135 90

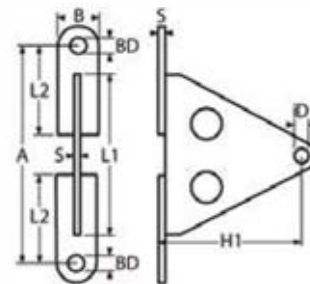

8499B135 90